

E11822

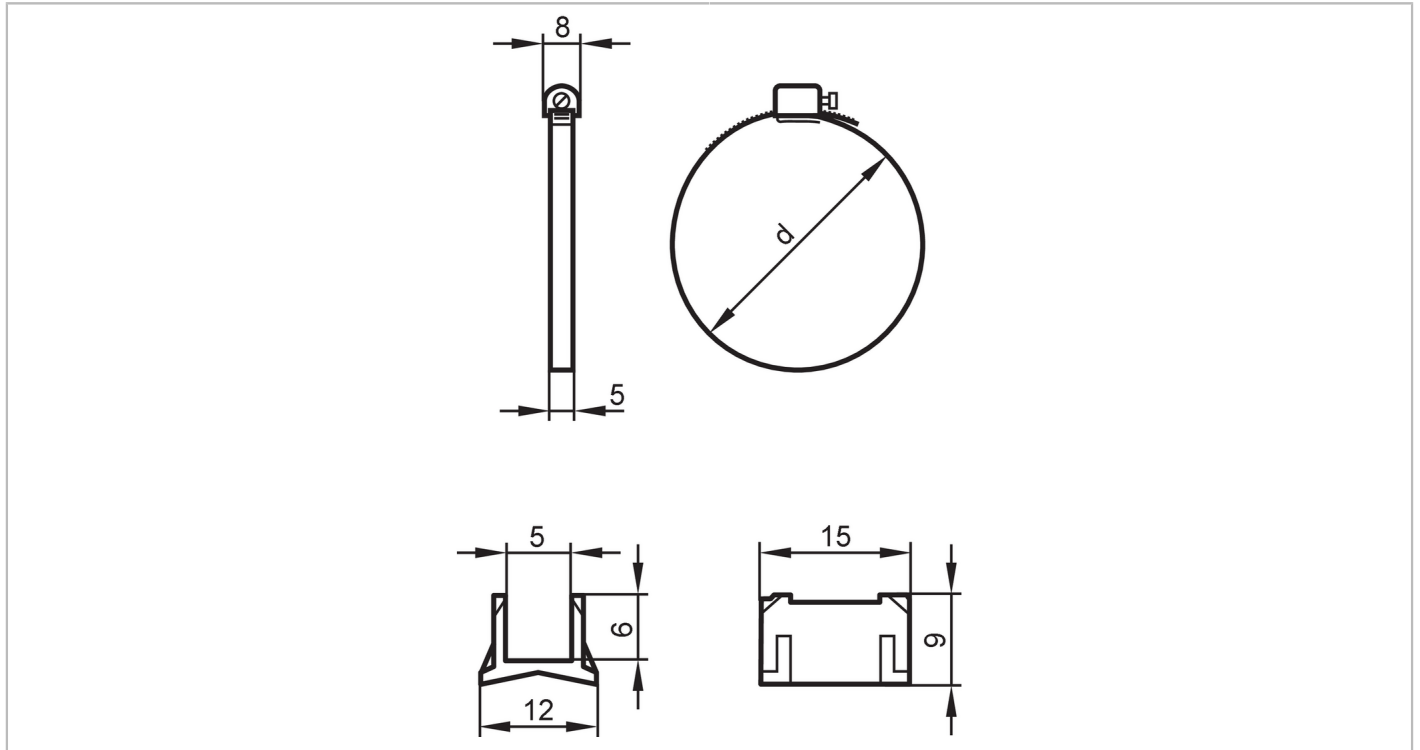

Fixing strap for clean-line cylinders

FIXING STRAP CLEAN-LINE CYL



Application	
Design	for types MKT
Mechanical data	
Weight [g]	9.7
Dimensions [mm]	Ø 80
Materials	Adapter: PA; fixing strap: stainless steel (303/1.4305)
Piston diameter [mm]	80
Clamping range [mm]	78...89
Accessories	
Items supplied	Adapter: 1 x for types MKT Fixing strap for clean-line cylinders: 1
Remarks	
Pack quantity	1 pcs.