

# EVT004

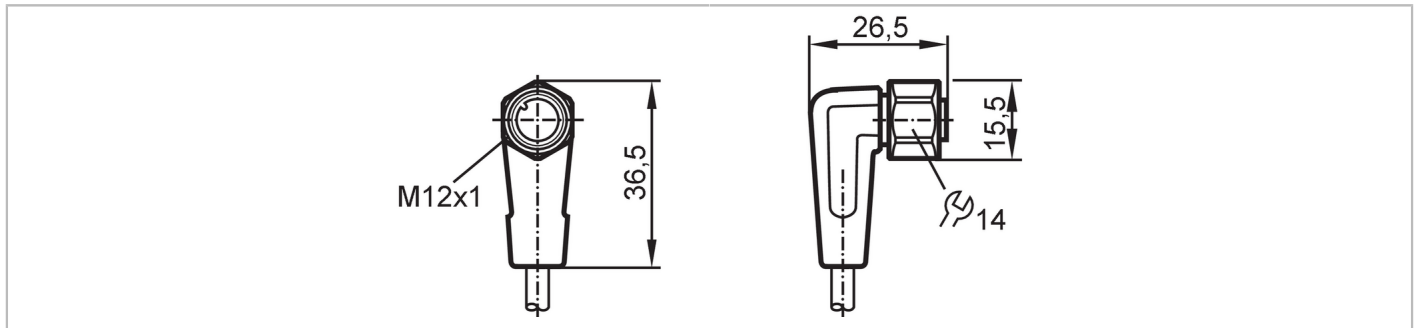

## Connecting cable with socket

ADOAH040VAS0005E04



Application		
Special feature	Free from silicone; Gold-plated contacts; Drag chain suitability	
Application	hygienic and wet areas in the food industry	
Free from silicone	yes	
Electrical data		
Operating voltage [V]	< 250 AC / < 300 DC	
Protection class	II	
Max. current load total [A]	4	
Operating conditions		
Ambient temperature [°C]	-25...100	
Note on ambient temperature	cULus: ...50	
Ambient temperature (moving) [°C]	5...100	
Note on ambient temperature (moving)	cULus: ...50	
Storage temperature [°C]	-25...55	
Storage humidity [%]	10...100	
Other climatic conditions for storage according to stated class	1K22/ DIN 60721-3-1	
Protection	IP 65; IP 67; IP 68; IP 69K	
Mechanical data		
Weight [g]	204.3	
Dimensions [mm]	26.5 x 15.5 x 36.5	
Moulded-body material	PVC	
Material nut	stainless steel (316L/1.4404)	
Sealing material	EPDM	
Drag chain suitability	yes	
Drag chain suitability	bending radius for flexible use	min. 10 x cable diameter
	travel speed	max. 3.3 m/s for a horizontal travel length of 5 m and max. acceleration of 5 m/s <sup>2</sup>
	bending cycles	> 1 Mio.
	torsional strain	± 180 °/m
Remarks		
Pack quantity	1 pcs.	

# EVT004



## Connecting cable with socket

ADOAH040VAS0005E04

### Electrical connection

Cable: 5 m, PVC, orange,  $\varnothing$  4.9 mm; 4 x 0.34 mm<sup>2</sup> (42 x  $\varnothing$  0.1 mm )

### Electrical connection - socket

Connector: 1 x M12, angled; coding: A; Contacts: 4, gold-plated; Moulded body: PVC, orange; Locking: stainless steel (316L/1.4404); Sealing: EPDM; Tightening torque: 0.6...1.5 Nm



### Connection



Core colours :  
BK = black  
BN = brown  
BU = blue  
WH = white