

ZH4227

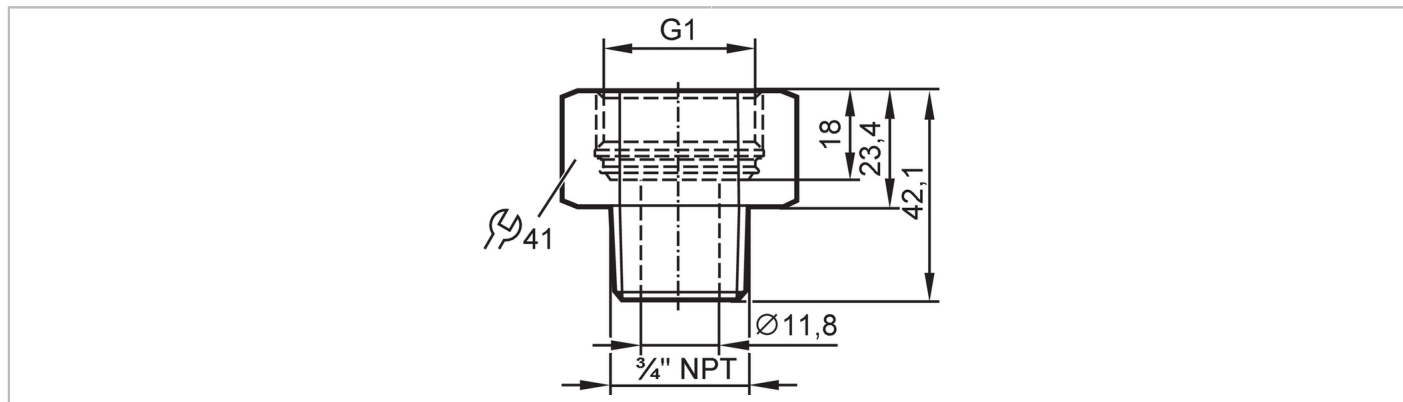

Screw-in adapter for process sensors

ADTR, G1 to 3/4" NPT



Application	
Pressure rating	[bar] 100
Mechanical data	
Weight	[g] 205
Material	stainless steel (1.4401 / 316); sealing: EPDM
Sensor connection	G 1 Aseptoflex Vario
Process connection	3/4" NPT
Remarks	
Pack quantity	1 pcs.