

TA2445

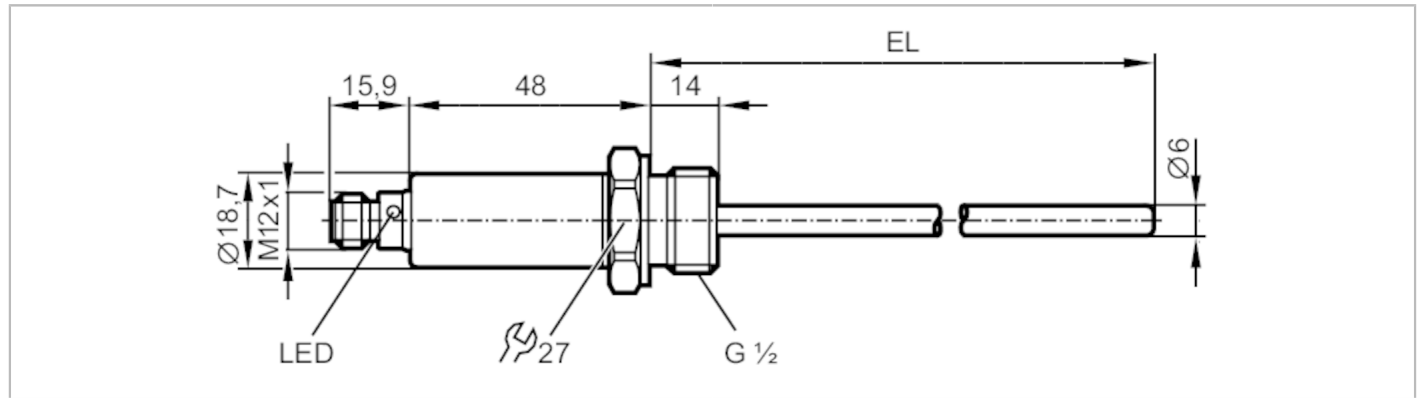

Temperature transmitter

TA-150CLER12-A-ZVG/US



Product characteristics	
Number of inputs and outputs	Number of analog outputs: 1
Measuring range [°C]	-50...150
Communication interface	IO-Link
Process connection	threaded connection G 1/2 external thread
Installation length EL [mm]	150
Application	
Special feature	gold-plated contacts
Measuring element	1 x Pt 1000; (to DIN EN 60751, class A)
Media	liquids and gases
Pressure rating	300 bar 30 MPa
Note on pressure rating	sensor When mounted in adapters the specifications of the adapter data sheet apply.
Electrical data	
Operating voltage [V]	18...32 DC; (cULus - Class 2 source required)
Current consumption [mA]	< 50
Protection class	III
Reverse polarity protection	yes
Power-on delay time [s]	1
Inputs / outputs	
Number of inputs and outputs	Number of analog outputs: 1
Outputs	
Total number of outputs	1
Output signal	analog signal; IO-Link; (configurable)
Number of analog outputs	1
Analog current output [mA]	4...20
Max. load [Ω]	250; ((18...19 V); 19...32 V: 300 Ω)
Short-circuit protection	yes
Overload protection	yes
Measuring/setting range	
Probe length L [mm]	136

TA2445



Temperature transmitter

TA-150CLER12-A-ZVG/US

Measuring range	[°C]	-50...150
Factory setting		-50...150 °C
Resolution		
Resolution of analog output	[K]	0.04
Accuracy / deviations		
Precision analog output	[K]	± 0,3 + (± 0,1 % MS)
Temperature coefficient [% of the span / 10 K]		0,1; (In case of deviation from the reference condition 25 ± 5 °C)
Reaction times		
Dynamic response T05 / T09	[s]	1 / 3
Interfaces		
Communication interface		IO-Link
Transmission type		COM2 (38,4 kBaud)
IO-Link revision		1.1
Profiles	Smart Sensor - SSP 0	Generic Profiled Sensor
	Function	Device identification
	Function	Process data variable
Min. process cycle time	[ms]	2.3
Supported DeviceIDs	Type of operation	DeviceID
	default	377
Operating conditions		
Ambient temperature	[°C]	-25...80
Storage temperature	[°C]	-40...100
Protection		IP 67; IP 68; IP 69K
Tests / approvals		
EMC	DIN EN 61000-6-2	
Shock resistance	DIN IEC 68-2-27	50 g (11 ms)
Vibration resistance	DIN IEC 68-2-6	20 g (10...2000 Hz)
MTTF	[years]	572
UL approval	UL approval number	K002
Mechanical data		
Weight	[g]	136.3
Housing		tubular
Dimensions	[mm]	Ø 18.7 / L = 213.9
Material		stainless steel (1.4404 / 316L); PEI; FKM
Materials (wetted parts)		stainless steel (1.4404 / 316L); O-ring: FKM
Tightening torque	[Nm]	45
Process connection		threaded connection G 1/2 external thread
Probe diameter	[mm]	6
Installation length EL	[mm]	150
Displays / operating elements		
Display	operating status	1 x LED, green
Remarks		
Remarks		MS = set measuring span

TA2445



Temperature transmitter

TA-150CLER12-A-ZVG/US

Pack quantity

1 pcs.

Electrical connection

Connector: 1 x M12; coding: A; Contacts: gold-plated



Connection

