

# EVC047



## Connection cable

VDOAH030MSS0001H03STGH030MSS

Please see the technical note under "Downloads"

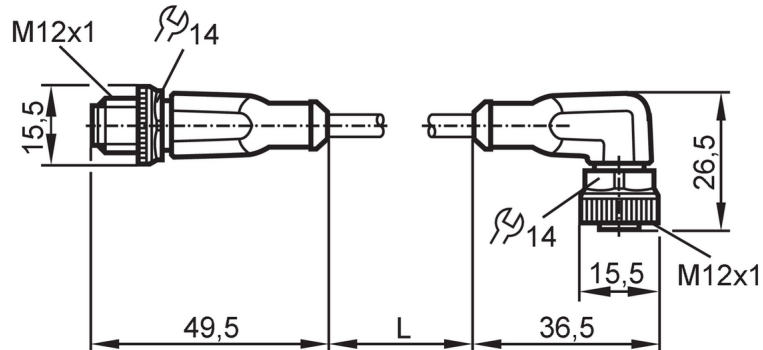

Application		
Special feature	Free from silicone; Halogen-free; gold-plated contacts; Drag chain suitability	
Free from silicone	yes	
Electrical data		
Operating voltage [V]	< 250 AC / < 300 DC	
Protection class	II	
Max. current load total [A]	4	
Operating conditions		
Ambient temperature [°C]	-25...90	
Note on ambient temperature	cULus: ...75	
Ambient temperature (moving) [°C]	-25...90	
Note on ambient temperature (moving)	cULus: ...75	
Storage temperature [°C]	-25...55	
Storage humidity [%]	10...100	
Other climatic conditions for storage according to stated class	1K22/ DIN 60721-3-1	
Protection	IP 65; IP 67; IP 68; IP 69K	
Mechanical data		
Weight [g]	60.1	
Molded-body material	TPU (urethane)	
Material nut	brass, nickel-plated	
Sealing material	FKM	
Drag chain suitability	yes	
Drag chain suitability	Bending radius for flexible applications	min. 10 x cable diameter
	Travel speed	max. 3.3 m/s for a horizontal travel length of 5 m and max. acceleration of 5 m/s <sup>2</sup>
	Bending cycles	> 5 Mio.
	Torsional strain	± 180 °/m

# EVC047



## Connection cable

VDOAH030MSS0001H03STGH030MSS

### Remarks

Notes	Please see the technical note under "Downloads"
Pack quantity	1 pcs.

### Electrical connection - plug

Connector: 1 x M12, straight; coding: A; Contacts: 3, gold-plated; Moulded body: TPU (urethane), orange; Locking: brass, nickel-plated; Tightening torque: 0.6...1.5 Nm



### Electrical connection

Cable: 1 m, PUR, Halogen-free, black, Ø 4.3 mm; 3 x 0.34 mm<sup>2</sup> (42 x Ø 0.1 mm )

### Connection

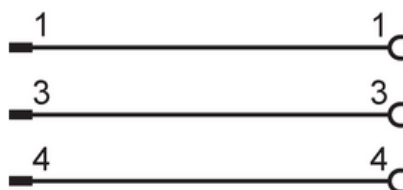

### Electrical connection - Socket

Connector: 1 x M12, angled; coding: A; Contacts: 3, gold-plated; Moulded body: TPU (urethane), orange; Locking: brass, nickel-plated; sealing: FKM; Tightening torque: 0.6...1.5 Nm

