

# EVC900

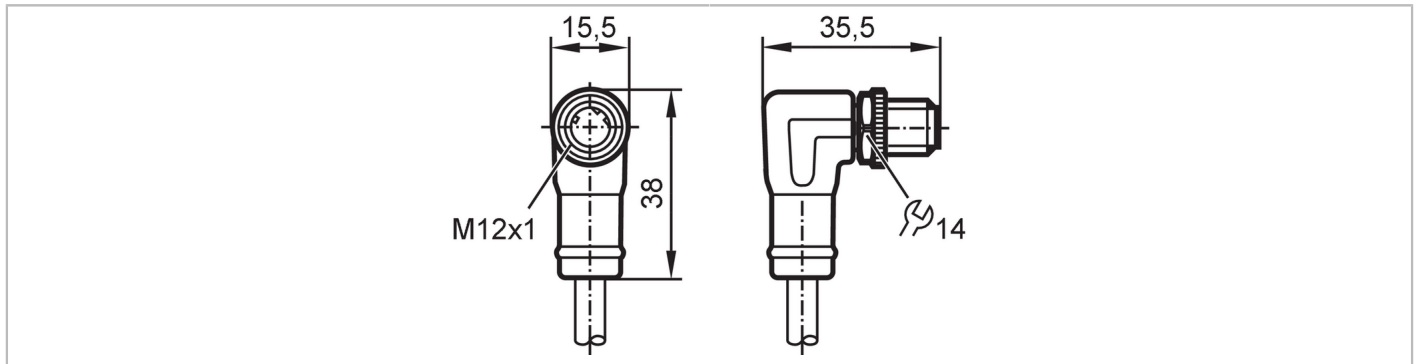

## All male cordsets

ASTAN040MSS0010K04



Application		
Special feature	Free from silicone; Halogen-free; gold-plated contacts; screened cable; Drag chain suitability	
Design	Ethernet cable, D-coded	
Application	Industrial applications; Oils and coolants; Industrial Ethernet; CAT5/CAT5e; 100 Mbit/s	
Free from silicone	yes	
Electrical data		
Operating voltage [V]	30 AC / 60 DC	
Protection class	III	
Max. current load total [A]	4	
Operating conditions		
Ambient temperature [°C]	-25...90	
Ambient temperature (moving) [°C]	-25...90	
Protection	IP 65; IP 67	
Mechanical data		
Weight [g]	624.8	
Molded-body material	TPU (urethane)	
Material nut	brass, nickel-plated	
Drag chain suitability	yes	
Drag chain suitability	Bending radius for flexible applications	min. 10 x cable diameter
	Travel speed	max. 3.3 m/s for a horizontal travel length of 5 m and max. acceleration of 5 m/s <sup>2</sup>
	Bending cycles	> 3 Mio.
	Torsional strain	± 180 °/m
Remarks		
Pack quantity	1 pcs.	

### Electrical connection - plug

Connector: 1 x M12, angled; coding: D; Contacts: 4, gold-plated; Moulded body: TPU (urethane), black; Locking: brass, nickel-plated; Tightening torque: 0.6...1.2 Nm; Shielded connection cable: shield connected



# EVC900



## All male cordsets

ASTAN040MSS0010K04

### Electrical connection

Cable: 10 m, PUR, Halogen-free, green, Ø 6.5 mm, screened; PROFINET Type C; 4 x 0.34 mm<sup>2</sup> (7 x Ø 0.25 mm)

### Connection

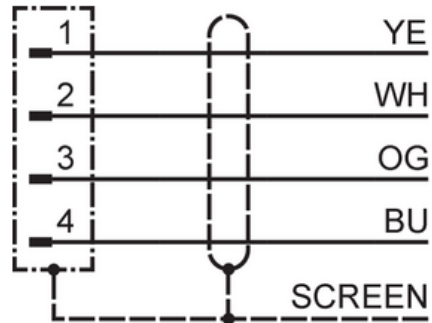

Core colors :  
BU = blue  
OG = orange  
WH = white  
YE = yellow