

EVC548

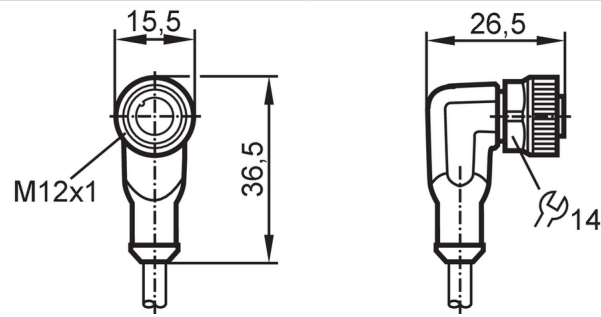

Female cordset

ADOAH050MSS0005K05



Application									
Special feature	Free from silicone; Halogen-free; gold-plated contacts; screened cable; Drag chain suitability								
Application	Industrial applications; Oils and coolants								
Free from silicone	yes								
Electrical data									
Operating voltage [V]	< 30 AC / < 36 DC								
Protection class	III								
Max. current load total [A]	4								
Overall current rating (UL) [A]	3								
Operating conditions									
Ambient temperature [°C]	-25...90								
Note on ambient temperature	cULus: ...75								
Ambient temperature (moving) [°C]	-25...90								
Note on ambient temperature (moving)	cULus: ...75								
Protection	IP 65; IP 67								
Mechanical data									
Weight [g]	212.8								
Dimensions [mm]	26.5 x 15.5 x 36.5								
Molded-body material	TPU (urethane)								
Material nut	brass, nickel-plated								
Sealing material	FKM								
Drag chain suitability	yes								
Drag chain suitability	<table border="0"> <tr> <td>Bending radius for flexible applications</td> <td>min. 10 x cable diameter</td> </tr> <tr> <td>Travel speed</td> <td>max. 3.3 m/s for a horizontal travel length of 5 m and max. acceleration of 5 m/s²</td> </tr> <tr> <td>Bending cycles</td> <td>≥ 2 Mio.</td> </tr> <tr> <td>Torsional strain</td> <td>± 180 °/m</td> </tr> </table>	Bending radius for flexible applications	min. 10 x cable diameter	Travel speed	max. 3.3 m/s for a horizontal travel length of 5 m and max. acceleration of 5 m/s ²	Bending cycles	≥ 2 Mio.	Torsional strain	± 180 °/m
Bending radius for flexible applications	min. 10 x cable diameter								
Travel speed	max. 3.3 m/s for a horizontal travel length of 5 m and max. acceleration of 5 m/s ²								
Bending cycles	≥ 2 Mio.								
Torsional strain	± 180 °/m								
Remarks									
Pack quantity	1 pcs.								

EVC548



Female cordset

ADOAH050MSS0005K05

Electrical connection

Cable: 5 m, PUR, Halogen-free, black, Ø 4.9 mm, screened; 5 x 0.25 mm² (32 x Ø 0.1 mm)

Electrical connection - Socket

Connector: 1 x M12, angled; coding: A; Contacts: 5, gold-plated; Moulded body: TPU (urethane), orange; Locking: brass, nickel-plated; sealing: FKM; Tightening torque: 0.6...1.5 Nm; Shielded connection cable: shield connected



Connection

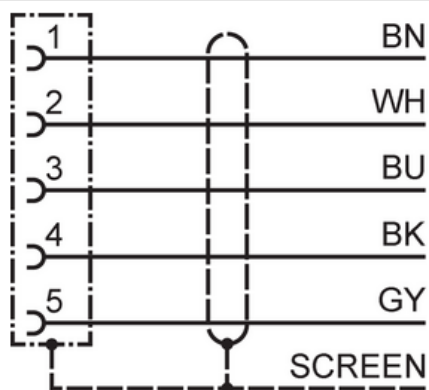

	Core colors :
BK =	black
BN =	brown
BU =	blue
GY =	grey
WH =	white

Diagrams and graphs

Shielding characteristics

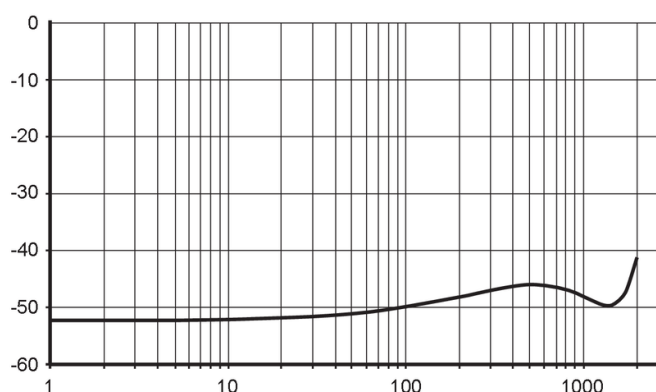

x Frequency (MHz)
y Shielding characteristics (dB)
according to DIN EN 60512-23-3