

EBC054

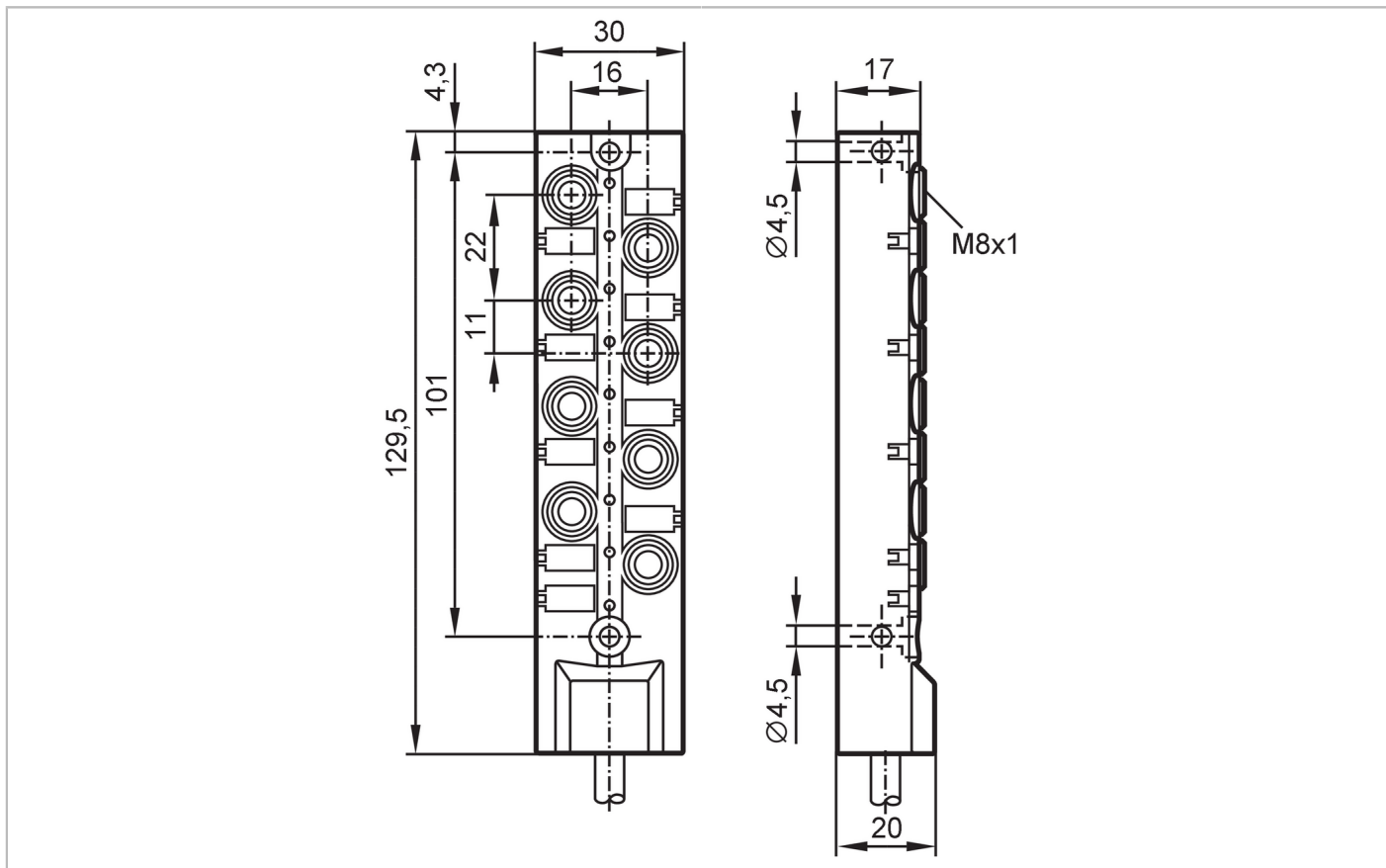

Wiring block

ZDO8F039MSS0005H10



Application	
Special feature	Halogen-free; gold-plated contacts; Drag chain suitability
Electrical data	
Operating voltage [V]	10...30 DC; (cULus - Class 2 source required)
Protection class	III
Max. current load per module/slot [A]	2
Max. current load total [A]	6
Outputs	
Electrical design	PNP
Operating conditions	
Ambient temperature [°C]	-25...80
Ambient temperature (moving) [°C]	-5...60
Protection	IP 65; IP 67; IP 68
Mechanical data	
Weight [g]	512
Housing	rectangular
Type of mounting	Backplane mounting
Dimensions [mm]	129.5 x 30 x 20

EBC054



Wiring block

ZDO8F039MSS0005H10

Material	housing: PBT-GF20	
Material nut	brass, nickel-plated	
Number of ports splitter box	8	
Connector type	M8	
Drag chain suitability	yes	
Drag chain suitability	Bending radius for flexible applications	min. 10 x cable diameter
	Travel speed	max. 3.3 m/s for a horizontal travel length of 5 m and max. acceleration of 5 m/s ²
	Bending cycles	> 5 Mio.
	Torsional strain	± 180 °/m

Displays / operating elements

Display	Switching status	8 x LED, yellow
	Power	1 x LED, green

Accessories

Accessories (optional)	DIN rail adapter:, E73007	
	Protective cap: M8, E73005	

Remarks

Pack quantity	1 pcs.
---------------	--------

Electrical connection

Cable: 5 m, PUR, Halogen-free, black, Ø 7.4 mm; 8 x 0.34 mm² (43 x Ø 0.1 mm) + 2 x 0.75 mm² (21 x Ø 0.2 mm)

Electrical connection - slot

Connector: 8 x M8; coding: A; Contacts: 3, gold-plated; Locking: brass, nickel-plated



EBC054



Wiring block

ZDO8F039MSS0005H10

Connection

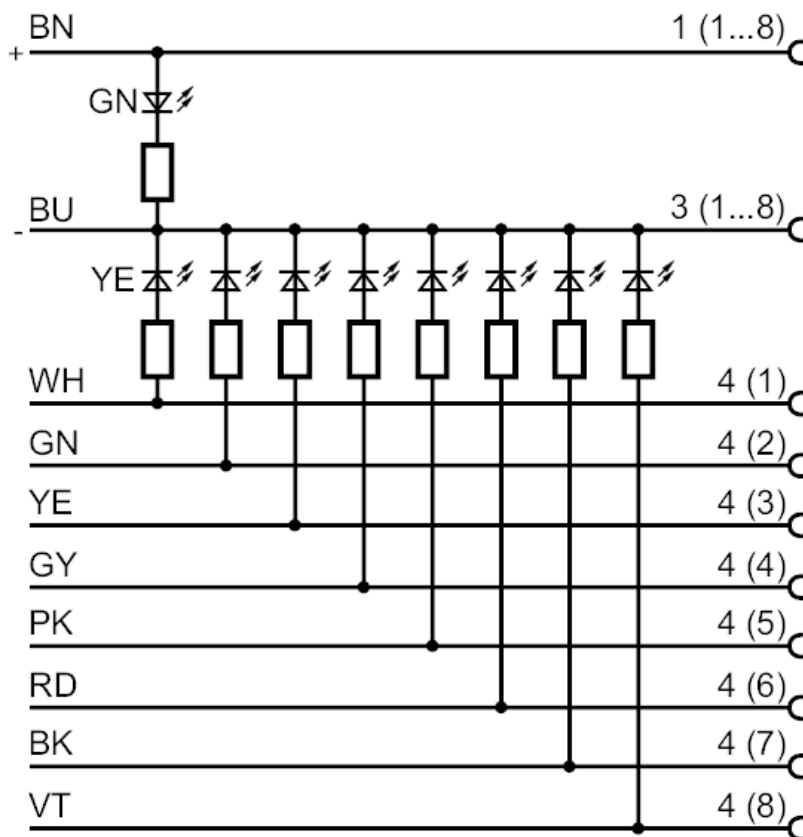

	Core colors :
BK =	black
BN =	brown
BU =	blue
GN =	green
GY =	grey
PK =	pink
RD =	red
VT =	lilac
WH =	white
YE =	yellow