

# E60212

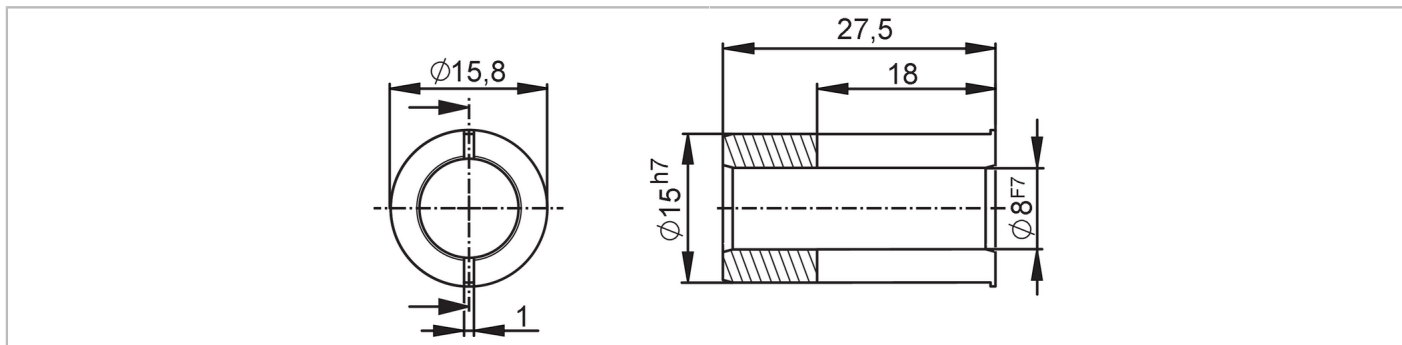

## Reducing bush

REDUCING SLEEVE FOR RO3 ROP15-8MM



Application	
Design	for hollow shaft encoders
Mechanical data	
Weight [g]	28.4
Inside diameter [mm]	8
Outer diameter [mm]	15
Material	stainless steel (1.4305 / 303)
Length [mm]	27.5
Remarks	
Pack quantity	1 pcs.