

E60210

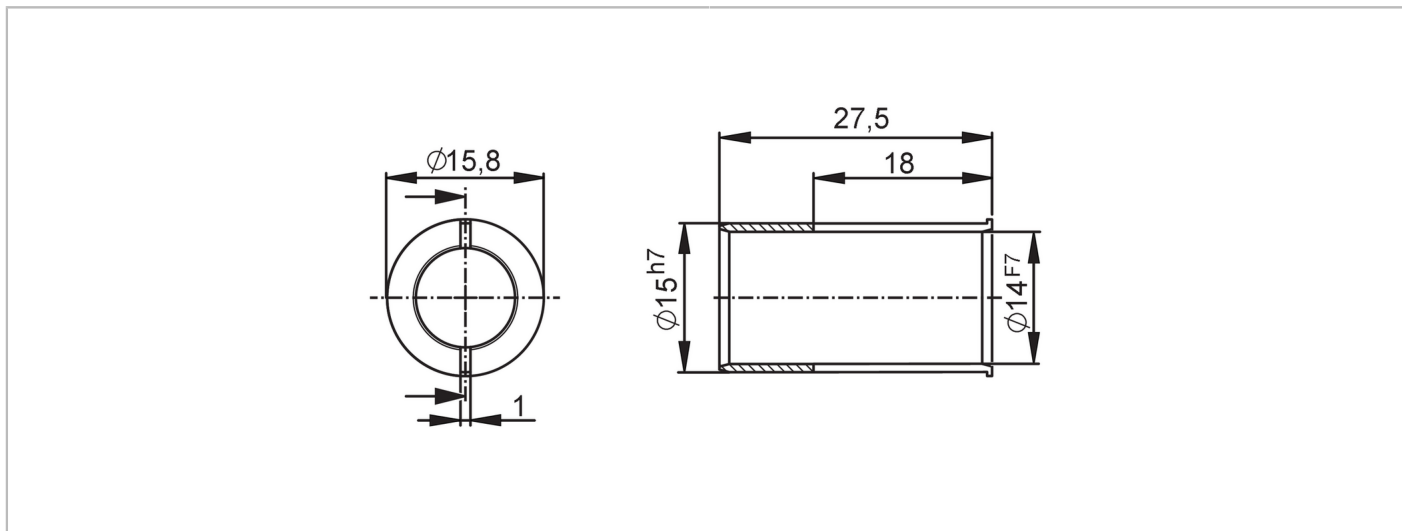

Reducing bush

REDUCING SLEEVE FOR RO3 ROP15-14MM



Application	
Design	for hollow shaft encoders
Mechanical data	
Weight [g]	6.8
Inside diameter [mm]	14
Outer diameter [mm]	15
Material	stainless steel (1.4305 / 303)
Length [mm]	27.5
Remarks	
Pack quantity	1 pcs.