

E43340

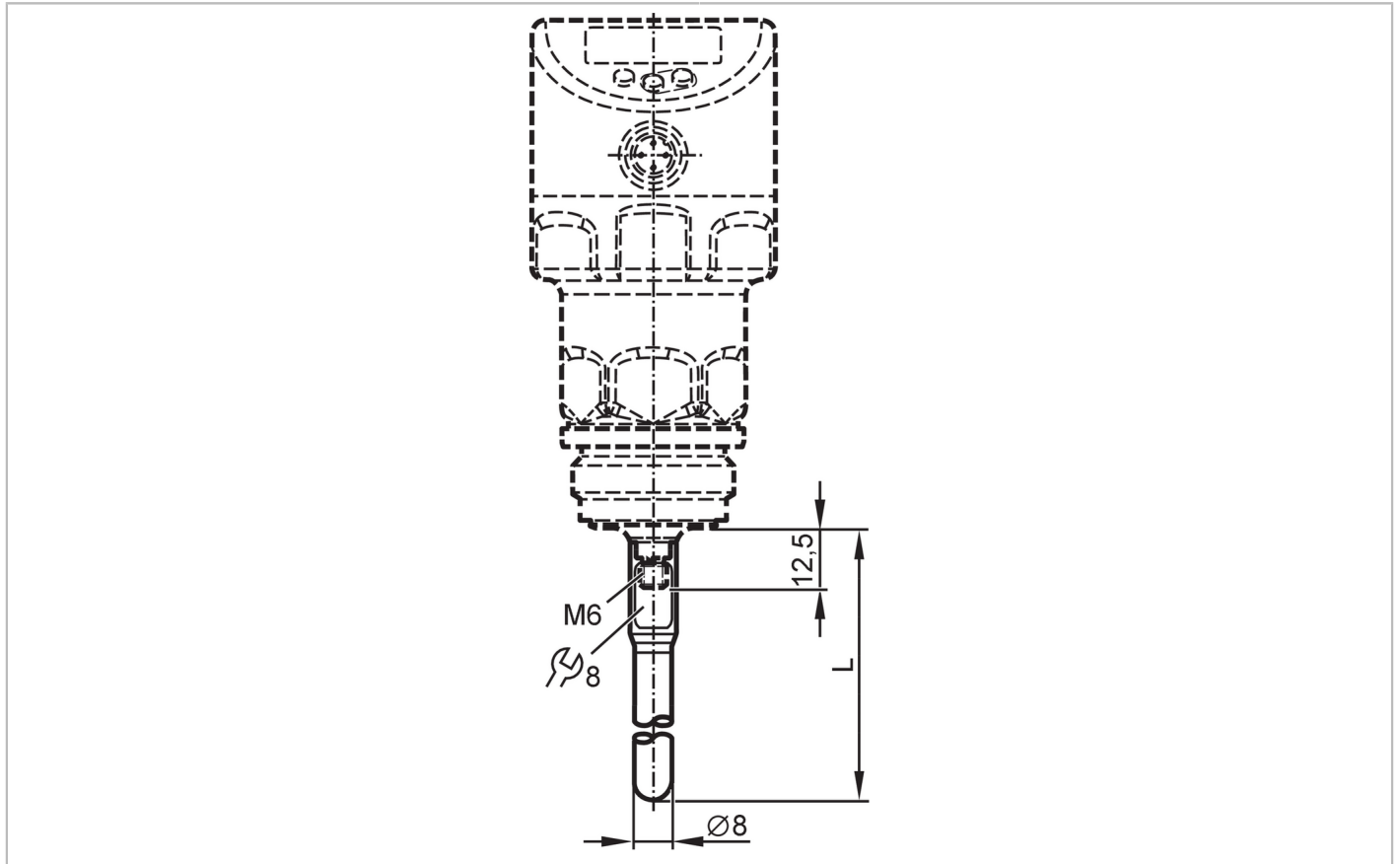

Probe for level sensors

LR HYGIENE PROBE L500



EC 1935/2004 EHEDG Certified FCM FDA

Application	
Design	sanitary, for level sensors LR
Application	hygienic systems
Measuring/setting range	
Probe length L [mm]	500
Mechanical data	
Weight [g]	218
Material	Probe: stainless steel (1.4404 / 316L) surface characteristics: Ra < 0,4 µm / Rz 4 µm
Tightening torque [Nm]	< 6.5
Surface characteristics Ra/Rz of the wetted parts	Ra < 0.8 µm / Rz = 8 µm
Hygienic equipment class to DIN 11866	H3
Remarks	
Pack quantity	1 pcs.