

E43226

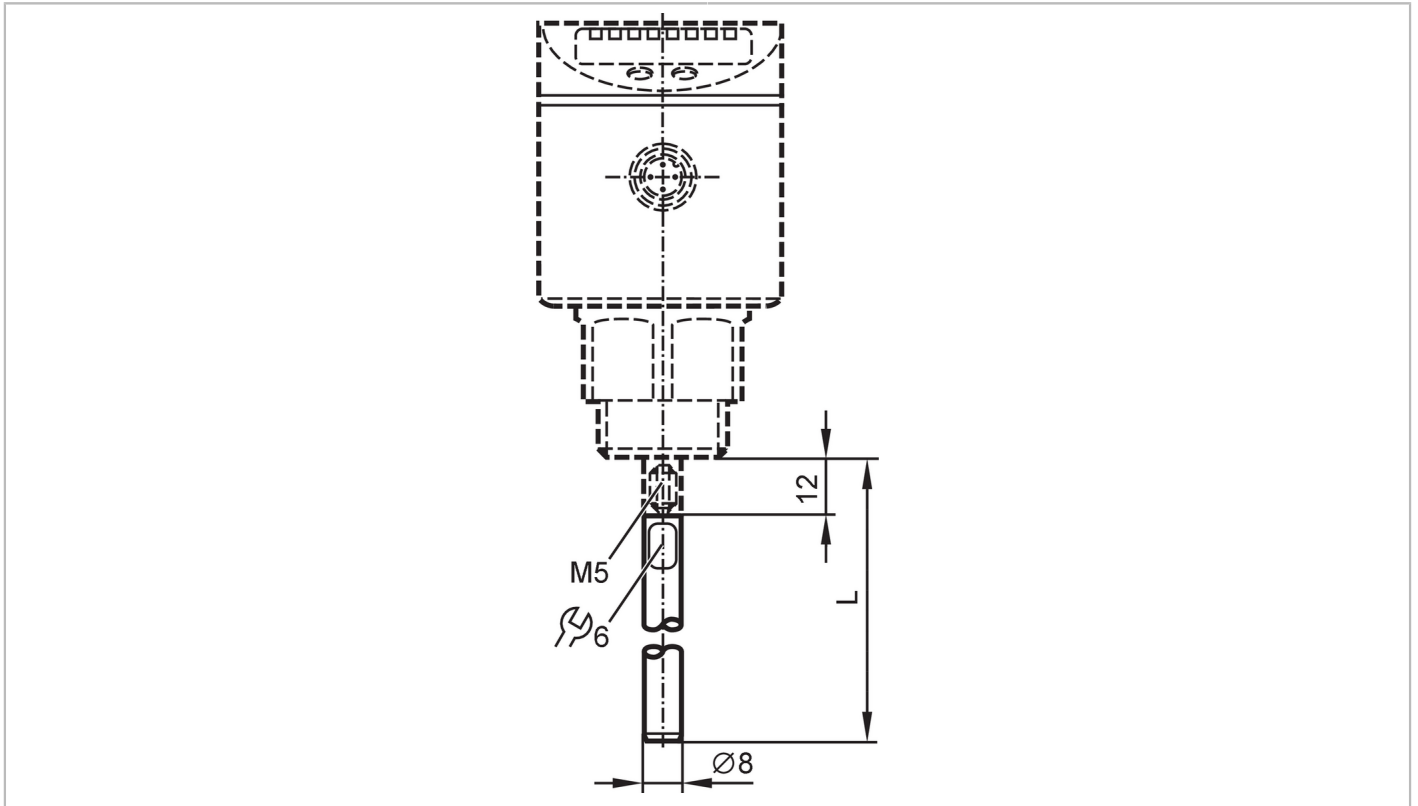

Probe for level sensors

LR PROBE L300



Application	
Design	for level sensors LR
Measuring/setting range	
Probe length L [mm]	300
Mechanical data	
Weight [g]	128.5
Material	stainless steel (1.4404 / 316L)
Tightening torque [Nm]	4
Remarks	
Pack quantity	1 pcs.