

E43204

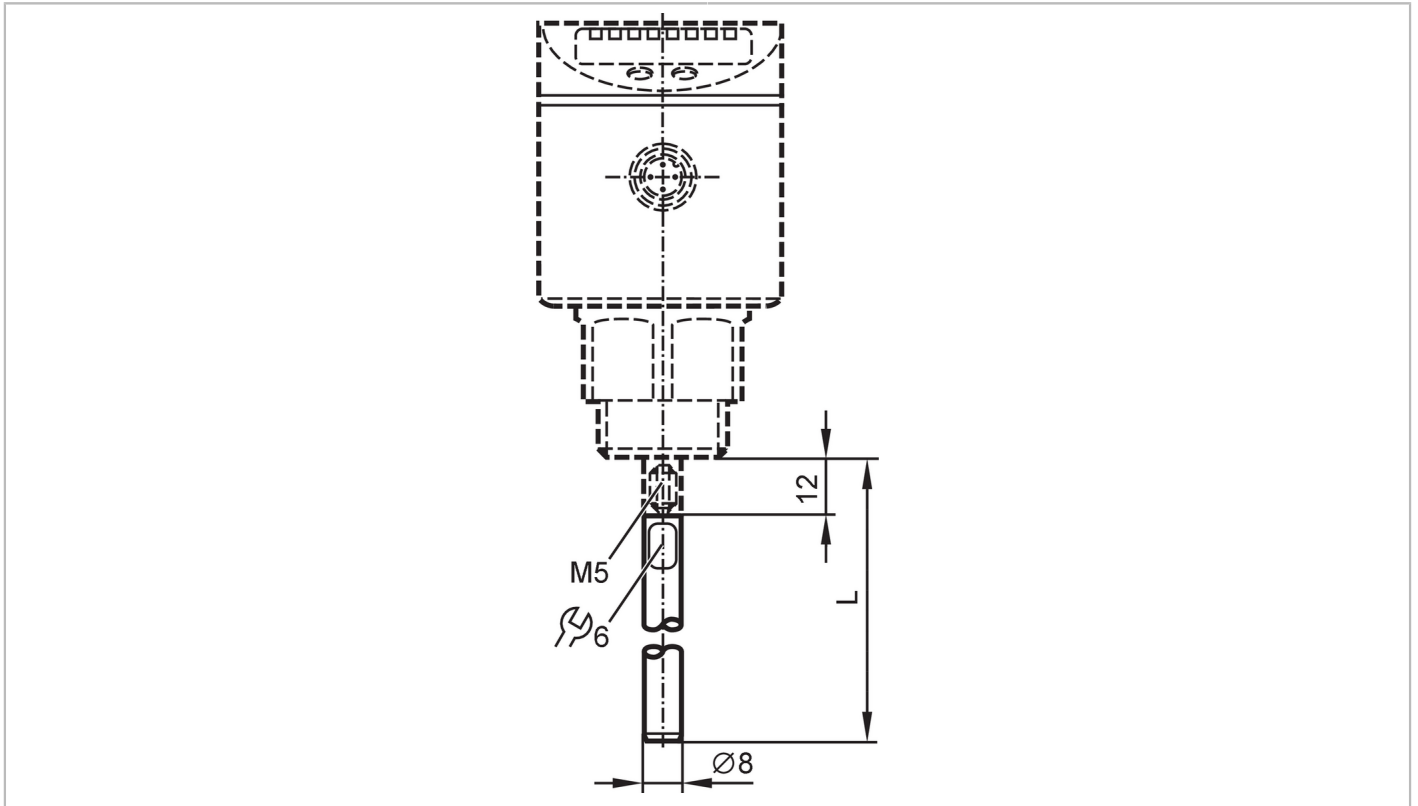

Probe for level sensors

LR PROBE L450



Application	
Design	for level sensors LR
Measuring/setting range	
Probe length L [mm]	450
Mechanical data	
Weight [g]	194.2
Material	stainless steel (1.4404 / 316L)
Tightening torque [Nm]	4
Remarks	
Pack quantity	1 pcs.