

E40545

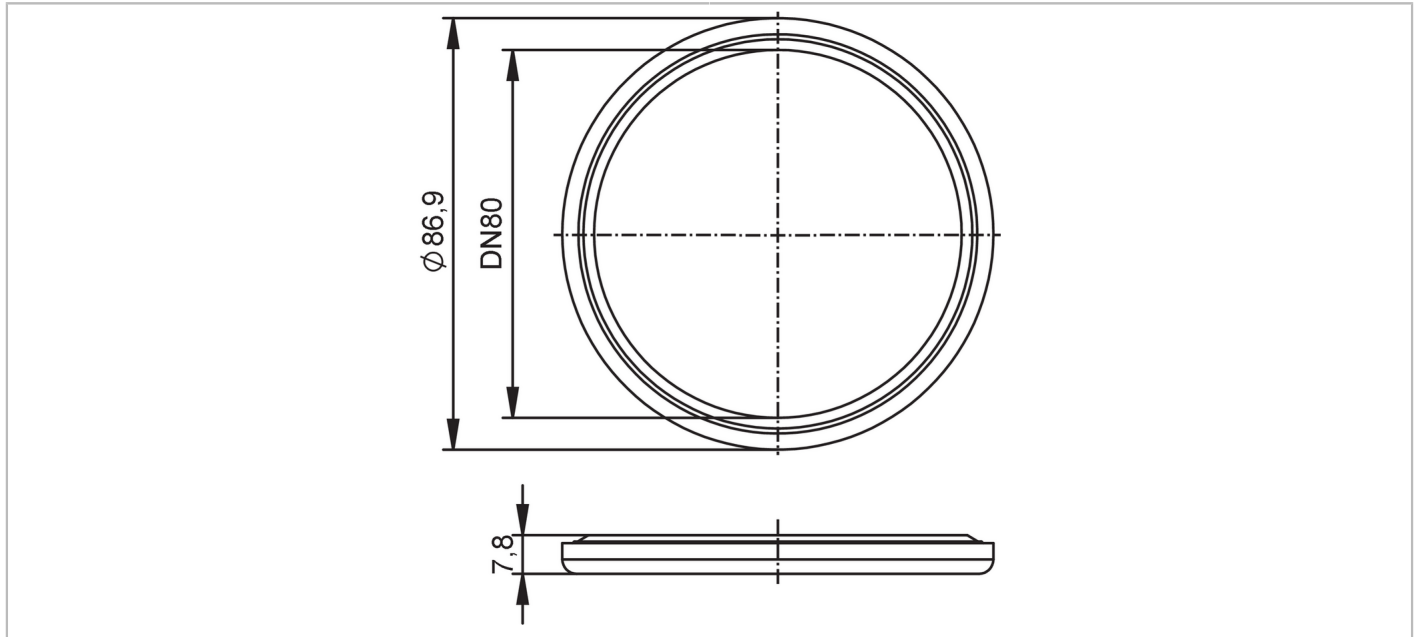

Gasket

SEAL RING FKM DN80



EC 1935/2004 FCM FDA

Application	
Design	for flow meter SMF
Application	food and beverage industry; hygienic systems
Medium temperature [°C]	0...150
Mechanical data	
Weight [g]	36.8
Housing	circular
Inside diameter [mm]	74.1
Outer diameter [mm]	86.9
Material	FKM
Nominal diameter	DN80 (3")
Remarks	
Pack quantity	2 pcs.