

E40543

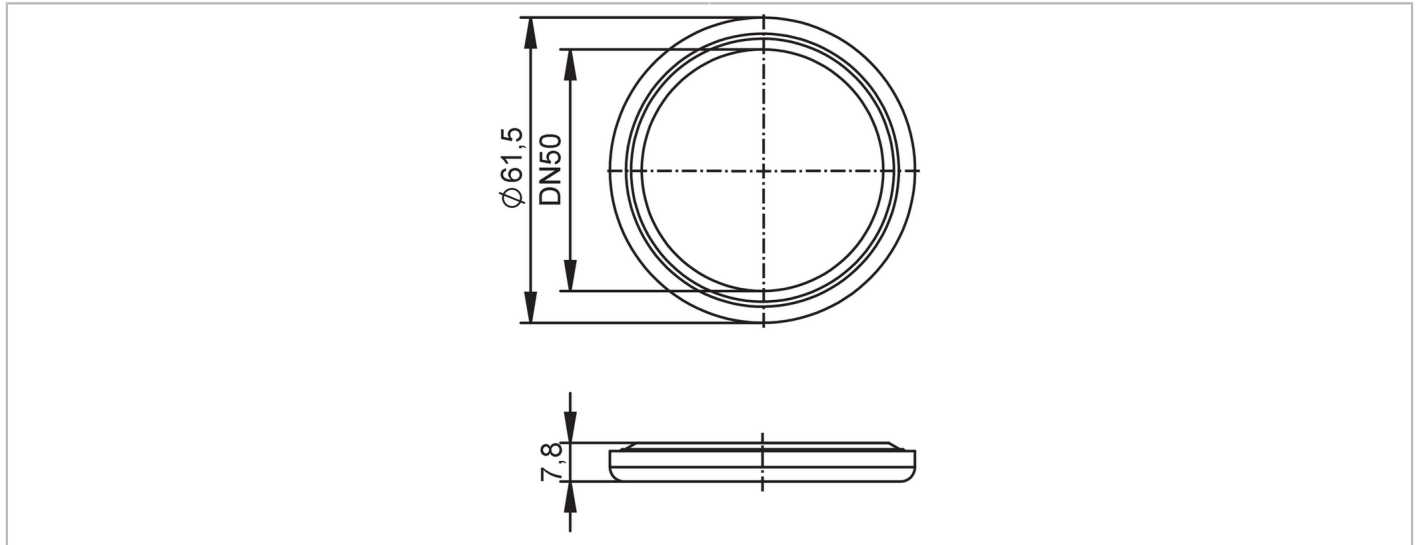

Gasket

SEAL RING FKM DN50



EC 1935/2004 FCM



Application	
Design	for flow meter SMF
Application	food and beverage industry; hygienic systems
Medium temperature [°C]	0...150
Mechanical data	
Weight [g]	24.5
Housing	circular
Inside diameter [mm]	48.7
Outer diameter [mm]	61.5
Material	FKM
Nominal diameter	DN50 (2")
Remarks	
Pack quantity	2 pcs.