

E21268

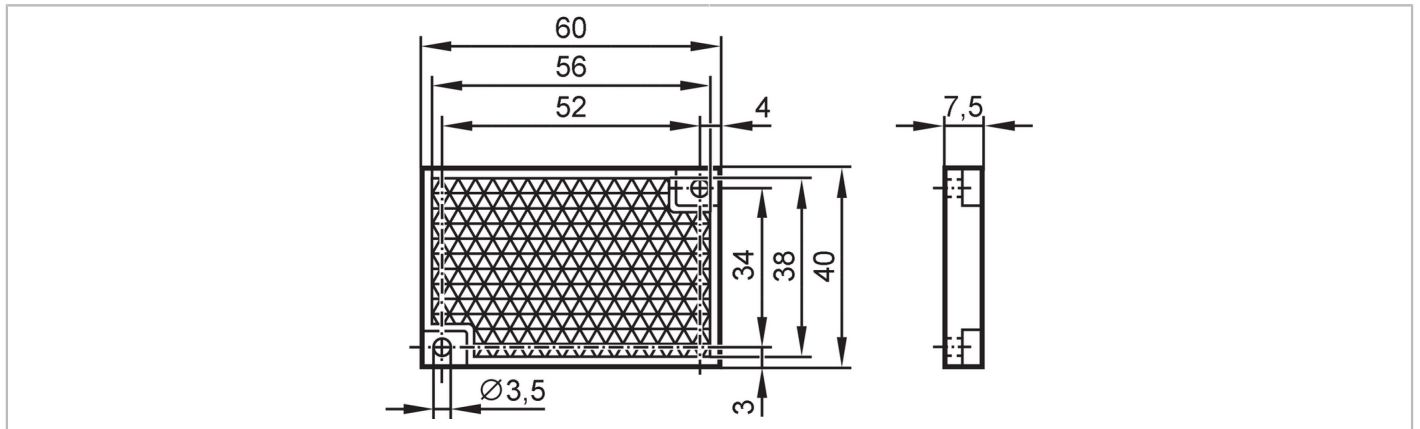

Reflector for retro-reflective sensors

REFLECTOR TS-56X38 SC



Application		
Design	For hygienic and wet areas in the food industry, rectangular, for red light and infrared light retro-reflective sensors	
Operating conditions		
Ambient temperature	[°C]	-20...140
Mechanical data		
Weight	[g]	14.6
Dimensions	[mm]	40 x 60 x 7.5
Reflector surface	[mm]	56 x 38
Material	Solidchem	
Remarks		
Pack quantity	1 pcs.	