

E18214

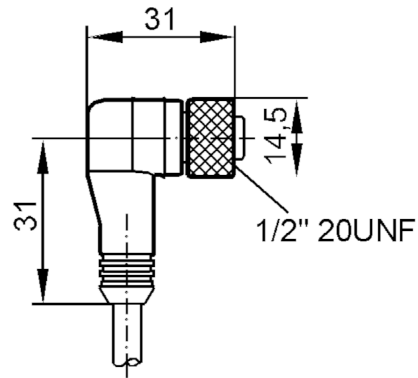

Female cordset

ADOAAO30MSS0002E03



Application

Special feature	gold-plated contacts
Application	Industrial applications

Electrical data

Operating voltage [V]	< 300 AC/DC
-----------------------	-------------

Operating conditions

Ambient temperature [°C]	-20...80
Protection	IP 68

Mechanical data

Weight [g]	72.575
Dimensions [mm]	31 x 14.5 x 31
Material	PVC
Molded-body material	PVC
Material nut	brass, nickel-plated

Remarks

Pack quantity	1 pcs.
---------------	--------

E18214



Female cordset

AD0AAO30MSS0002E03

Electrical connection

Cable: 2 m, PVC, yellow; 3 x 0.34 mm² / AWG 22

Electrical connection - Socket

Connector: 1 x 1/2", angled; coding: C; Contacts: 3, gold-plated; Moulded body: PVC; Locking: brass, nickel-plated

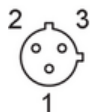

Connection

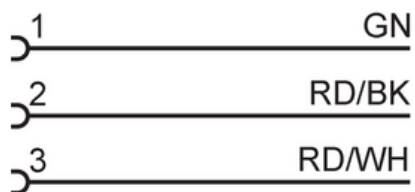

GN = green
RD/BK = red/black
RD/WH = red/white