

E18406

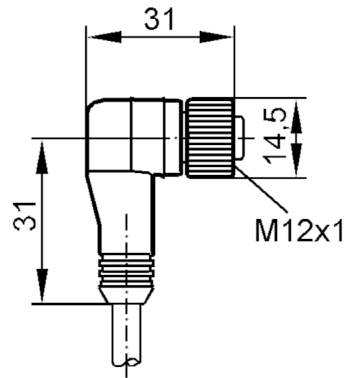

Female cordset

ADOAH040MSC0005X04



Application

Special feature	gold-plated contacts
Application	Industrial applications

Electrical data

Operating voltage	[V]	< 300 AC/DC
-------------------	-----	-------------

Operating conditions

Ambient temperature	[°C]	-45...105
Protection		IP 68

Mechanical data

Weight	[g]	385.553
Dimensions	[mm]	31 x 14.5 x 31
Molded-body material		TPE
Material nut		zinc, PTFE coated

Remarks

Pack quantity	1 pcs.
---------------	--------

Electrical connection

Cable: 5 m, yellow; 4 x 0.75 mm² / AWG 18

Electrical connection - Socket

Connector: 1 x M12, angled; coding: A; Contacts: 4, gold-plated; Moulded body: TPE; Locking: zinc, PTFE coated



E18406



Female cordset

ADOAH040MSC0005X04

Connection

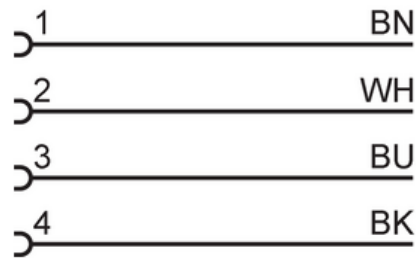

Core colors :
BK = black
BN = brown
BU = blue
WH = white