

E11745

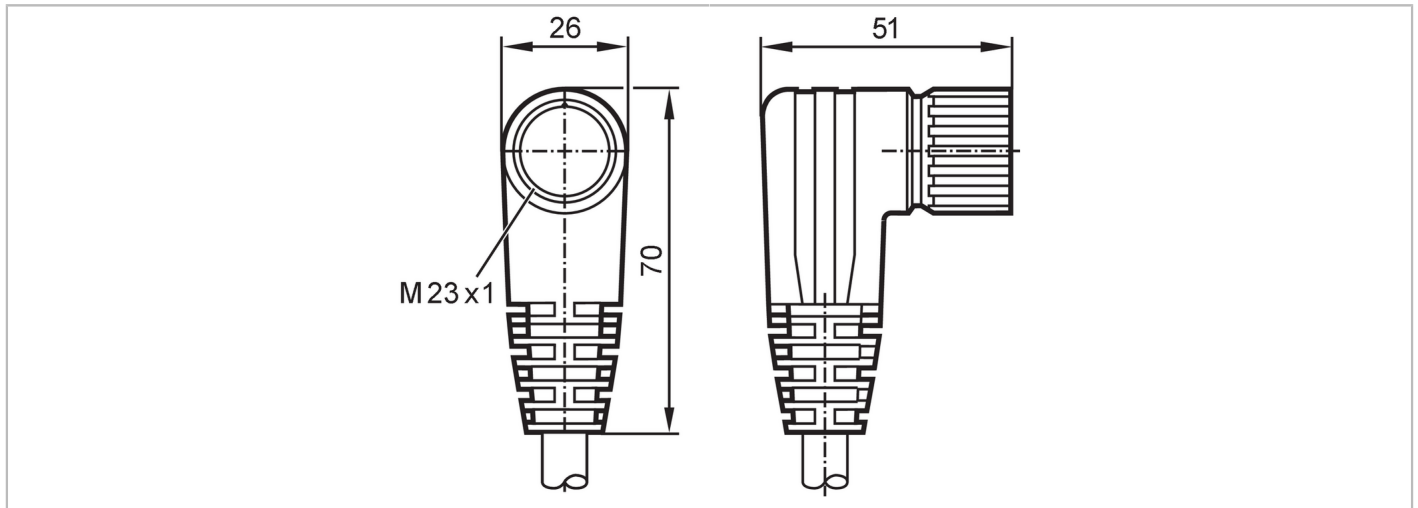

Female cordset

ADOAK190MSS0005H19



Application		
Special feature	Halogen-free; Drag chain suitability	
Application	Industrial applications	
Electrical data		
Operating voltage [V]	< 63 AC/DC	
Max. current load total [A]	8	
Operating conditions		
Ambient temperature [°C]	-25...80	
Protection	IP 67	
Mechanical data		
Weight [g]	1165	
Dimensions [mm]	51 x 26 x 70	
Molded-body material	PUR	
Material nut	brass, nickel-plated	
Tightening torque [Nm]	2	
Drag chain suitability	yes	
Drag chain suitability	Bending radius for flexible applications	min. 10 x cable diameter
	Travel speed	max. 2 m/s
	Bending cycles	> 500000
	Torsional strain	± 30 °/m
Remarks		
Pack quantity	1 pcs.	

E11745



Female cordset

ADOAK190MSS0005H19

Electrical connection

Cable: 5 m, PUR, Halogen-free, black, \varnothing 11.6 mm; 16 x 0.5 mm² (63 x \varnothing 0.1 mm) + 3 x 1.0 mm² (127 x \varnothing 0.1 mm)

Electrical connection - Socket

Connector: 1 x M23, angled; Contacts: 19; Moulded body: PUR, black; Locking: brass, nickel-plated

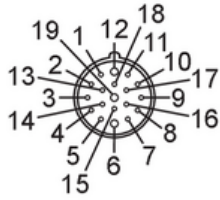

E11745



Female cordset

ADOAK190MSS0005H19

Connection

1	VT
2	RD
3	GY
4	RD/BU
5	GN
6	BU
7	GY/PK
8	WH/GN
9	WH/YE
10	WH/GY
11	BK
12	GN/YE
13	YE/BN
14	BN/GN
15	WH
16	YE
17	PK
18	GY/BN
19	BN

	Core colors :
BK =	black
BN =	brown
BU =	blue
GN =	green
GY =	grey
PK =	pink
RD =	red
VT =	lilac
WH =	white
YE =	yellow