

DV1102



LED strip RGBW

LED-Strip-RGBW-transp-500mm-cl

IO-Link-capable with DP1615

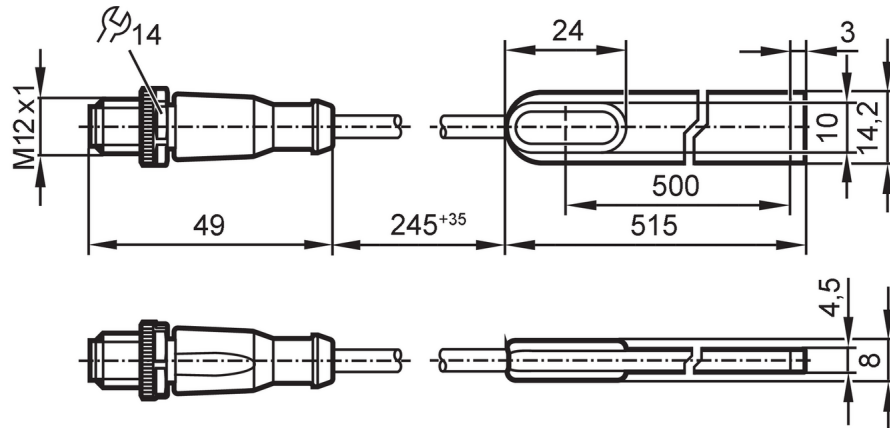

Application

Special feature	Halogen-free; gold-plated contacts
Application	signaling machine conditions

Electrical data

Operating voltage	[V]	21.6...26.4 DC
Nominal voltage DC	[V]	24; (to SELV/PELV)
Max. current consumption	[mA]	720; (red: 160; green: 160; blue: 160; white: 240)
Color temperature	[K]	7500
Luminous flux	[lm]	red: 184.96; green: 572; blue: 116; white: 768.32
Note on luminous flux	[lm]	luminous flux indications refer to one meter of LED strip
Typ. lifetime	[h]	38000

Inputs

Input circuit of digital inputs	24 V PNP
---------------------------------	----------

Operating conditions

Ambient temperature	[°C]	-20...45
Max. relative air humidity	[%]	90
Max. height above sea level	[m]	4000
Protection		IP 68
Degree of soiling		2

Tests / approvals

Approval	EN 62471; IEC 62031
----------	---------------------

Mechanical data

Weight	[g]	75.4
Dimensions	[mm]	515 x 14.2 x 4.5
Material		housing: TPU (urethane)
Sealing material		FKM

DV1102



LED strip RGBW

LED-Strip-RGBW-transp-500mm-cl

Displays / operating elements		
Display	signaling machine conditions	LED, multi-color RGB
	mounting light	LED, white
Remarks		
Notes	IO-Link-capable with DP1615	
Pack quantity	1 pcs.	

Electrical connection

Cable: 0.3 m, PUR, Halogen-free, black, Ø 4.3 mm; 5 x 0.34 mm² (42 x Ø 0.1 mm)

Connector: M12, straight; coding: A; Moulded body: TPU (urethane), orange; Locking: brass, nickel-plated; sealing: FKM; Contacts: gold-plated; Tightening torque: 0.6...1.5 Nm

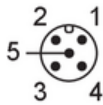

- 1 + red
- 2 + green
- 3 GND
- 4 + white
- 5 + blue

Diagrams and graphs

light intensity distribution curve

