

E11801

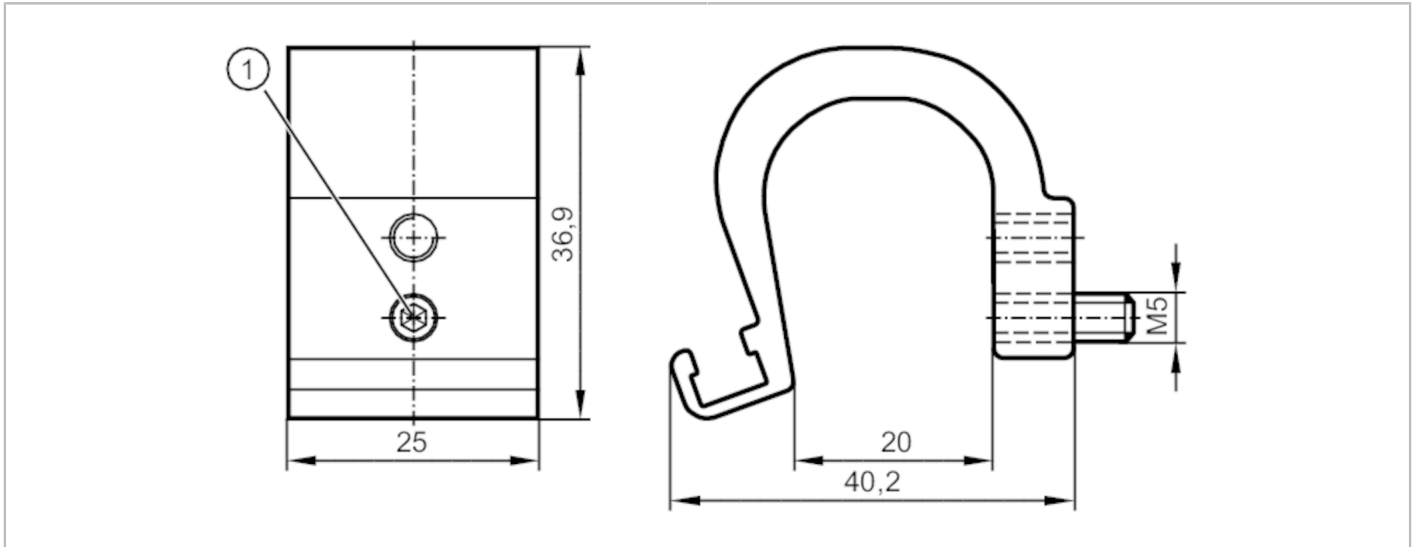

Mounting adapter for tie-rod/integrated profile cylinders

ADAPT TIE ROD/PROFILE CYL



Application

Design for types MKT

Mechanical data

Weight [g] 31.5

Materials aluminium; screw: stainless steel

Clamping range [mm] 14...20

Remarks

Pack quantity 1 pcs.