

RU6079



Incremental encoder with solid shaft

RU-4096-I24/K

Article no longer available - archive entry

Discontinuation date: 31.03.2016

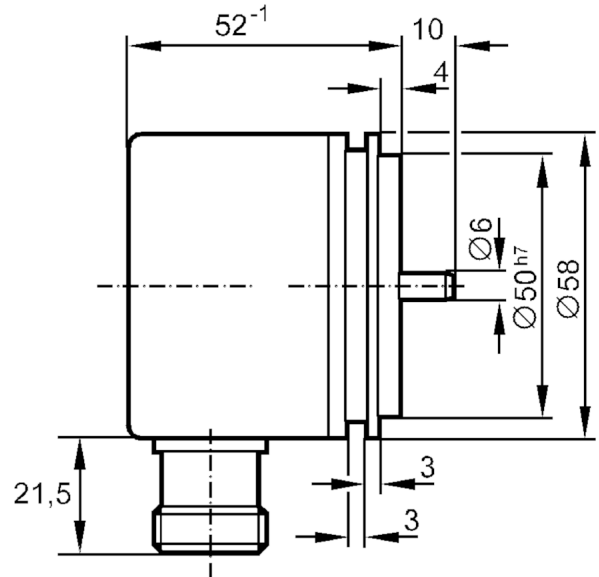
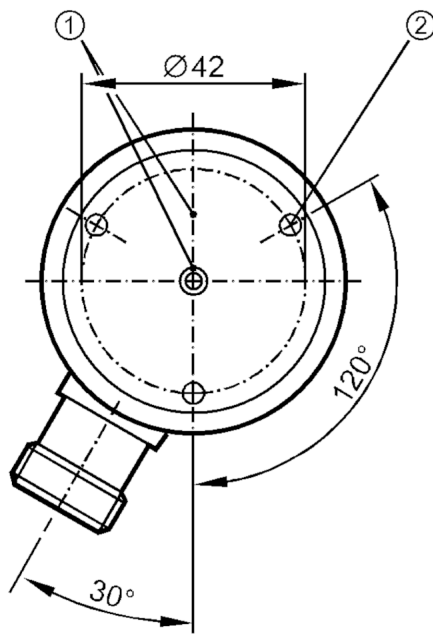

- 1 reference mark
- 2 M4 Depth 5 mm



Product characteristics

Resolution	4096 resolution
Shaft design	solid shaft
Shaft diameter [mm]	6

Application

Function principle	incremental
--------------------	-------------

Electrical data

Operating voltage [V]	10...30 DC
Current consumption [mA]	150

Outputs

Electrical design	HTL
Max. current load per output [mA]	50
Switching frequency [kHz]	300
Type of short-circuit protection	< 60 s
Phase difference A and B [°]	90

Measuring/setting range

Resolution	4096 resolution
------------	-----------------

RU6079



Incremental encoder with solid shaft

RU-4096-I24/K

Operating conditions		
Ambient temperature	[°C]	-30...85
Storage temperature	[°C]	-30...100
Max. relative air humidity	[%]	98
Protection		IP 64

Tests / approvals		
Shock resistance		100 g (6 ms)
Vibration resistance		15 g (55...2000 Hz)
MTTF	[years]	190

Mechanical data		
Weight	[g]	420
Dimensions	[mm]	Ø 58 / L = 62
Materials		aluminium
Max. revolution, mechanical	[U/min]	12000
Max. starting torque	[Nm]	1
Reference temperature torque	[°C]	20
Shaft design		solid shaft
Shaft diameter	[mm]	6
Shaft material		steel (1.4104)
Max. shaft load axial (at the shaft end)	[N]	10
Max. shaft load radial (at the shaft end)	[N]	20
Fixing flange		synchro-flange

Remarks	
Notes	discontinued article

Electrical connection	
1	B inverted
2	L+ sensor
3	0 index
4	0 index inverted
5	A
6	A inverted
screen	housing
7	failure inverted
8	B
9	n.c.
10	0V (Un)
11	0V sensor
12	L+

Connector: 1 x M23 (ifm 1001.4), radial

RU6079



Incremental encoder with solid shaft

RU-4096-I24/K

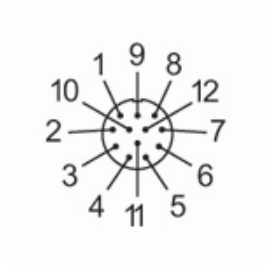

Diagrams and graphs

Pulse diagram

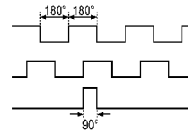

Output A

Output B

0 index

Article no longer available - archive entry

Discontinuation date: 31.03.2016