

EVF693

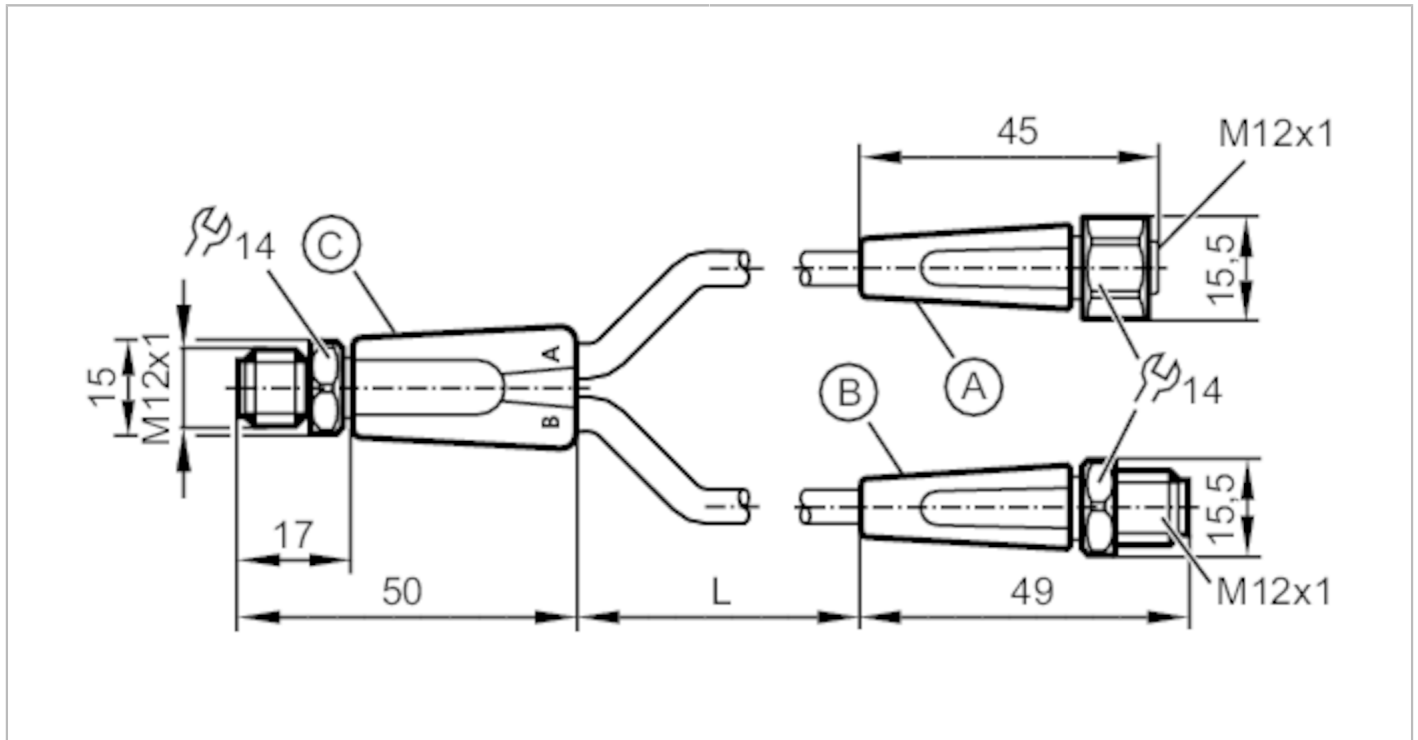

Cablu de conexiune in Y

YDSGHDA0VAS0001PDASTGH030VAS



Aplicatie		
Caracteristici speciale	fără silicon; Fara Halogen; contacte aurite; Adecvat portcablu	
Aplicatie	medii igienice si umede din industria alimentara	
Fără silicon	da	
Date electrice		
Tensiune de lucru [V]	< 24 DC	
Clasa de protectie	III	
Curent total Max. [A]	4	
Condițiile mediului		
Temperatură de ambianță [°C]	-25...100	
Protectie	IP 65; IP 67; IP 68; IP 69K	
Date mecanice		
Greutate [g]	100,8	
Material turnat	PP	
Material piuliță	inox (1.4404 / 316L)	
Material de etansare	EPDM	
Numarul de porturi splitter box	2	
Adecvat portcablu	da	
Adecvat portcablu	Rază de îndoire la aplicații flexibile	min. 10 x diametrul cablului
	Viteză lucru	max. 3,3 m/s la 5 m lungime lucru orizontală și accelerație max. de 5 m/s ²
	Ciclii îndoire	> 5 Mio.
	Deformare la torsiune	± 180 °/m

EVF693



Cablu de conexiune in Y

YDSGHDA0VAS0001PDASTGH030VAS

Observații

Unitate de ambalare

1 buc.

Conectare electrică

Cablu: 1 m, MPPE, Fara Halogen, gri, Ø 5,1 mm; 2 x 0,34 mm² (42 x Ø 0,1 mm) + 5 x 0,34 mm² (42 x Ø 0,1 mm)

Conectare electrică - mufa C

Conector: 1 x M12, drept; Corp turnat: PP, gri; Blocare: inox (1.4404 / 316L); Contacte: aurit; Moment de strângere: 0,6...1,2 Nm



Conectare electrică - Conector mama A

Conector: 1 x M12, drept; Corp turnat: PP, gri; Blocare: inox (1.4404 / 316L); Etanșare: EPDM; Contacte: aurit; Moment de strângere: 0,6...1,5 Nm

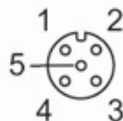

Conectare electrică - mufa B

Conector: 1 x M12, drept; Corp turnat: PP, gri; Blocare: inox (1.4404 / 316L); Contacte: aurit; Moment de strângere: 0,6...1,5 Nm





Cablu de conexiune in Y

YDSGHDA0VAS0001PDASTGH030VAS

Conectare electrică - Racord

Racord

