

RV6026



Incremental encoder with solid shaft

RV-1080-I24/L2

Article no longer available - archive entry

Alternative article: RV3500 When selecting an alternative article and accessories please note that technical data may differ! –
When selecting an alternative article and accessories please note that technical data may differ! – Discontinuation date: 31.03.2016

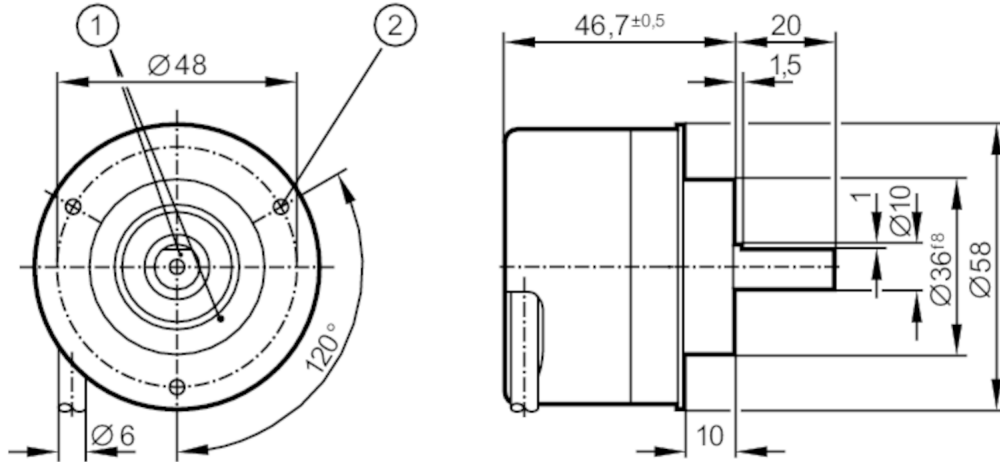

- 1 reference mark
- 2 M3 Depth 5 mm



Product characteristics

Resolution	1080 resolution
Shaft design	solid shaft
Shaft diameter [mm]	10

Application

Function principle	incremental
--------------------	-------------

Electrical data

Operating voltage [V]	10...30 DC
Current consumption [mA]	< 150

Outputs

Electrical design	HTL
Max. current load per output [mA]	50
Switching frequency [kHz]	300
Type of short-circuit protection	< 60 s
Phase difference A and B [°]	90

Measuring/setting range

Resolution	1080 resolution
------------	-----------------

RV6026



Incremental encoder with solid shaft

RV-1080-I24/L2

Operating conditions	
Ambient temperature [°C]	-40...100
Note on ambient temperature	for firmly laid cable: -40 °C
Max. relative air humidity [%]	98
Protection	IP 64; (on the housing: IP 67; on the shaft: IP 64)
Tests / approvals	
Shock resistance	200 g
Vibration resistance	30 g
MTTF [years]	190
Mechanical data	
Weight [g]	467.2
Dimensions [mm]	Ø 58 / L = 46.7
Materials	aluminium
Max. revolution, mechanical [U/min]	12000
Max. starting torque [Nm]	1
Reference temperature torque [°C]	20
Shaft design	solid shaft
Shaft diameter [mm]	10
Shaft material	steel (1.4104)
Max. shaft load axial (at the shaft end) [N]	10
Max. shaft load radial (at the shaft end) [N]	20
Remarks	
Notes	discontinued article
Electrical connection	
Cable: 2 m, PUR; Maximum cable length: 300 m; radial, can also be used axially	
brown	A
green	A inverted
grey	B
pink	B inverted
red	0 index
black	0 index inverted
blue	L+ sensor
white	0V sensor
brown/green	L+ (Up)
white/green	0V (Un)
lilac	failure inverted
screen	housing

RV6026



Incremental encoder with solid shaft

RV-1080-I24/L2

Diagrams and graphs

Pulse diagram

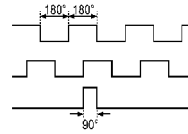

Output A

Output B

0 index

Article no longer available - archive entry

Alternative article: RV3500 When selecting an alternative article and accessories please note that technical data may differ! –
When selecting an alternative article and accessories please note that technical data may differ! – Discontinuation date: 31.03.2016