

# EVF266

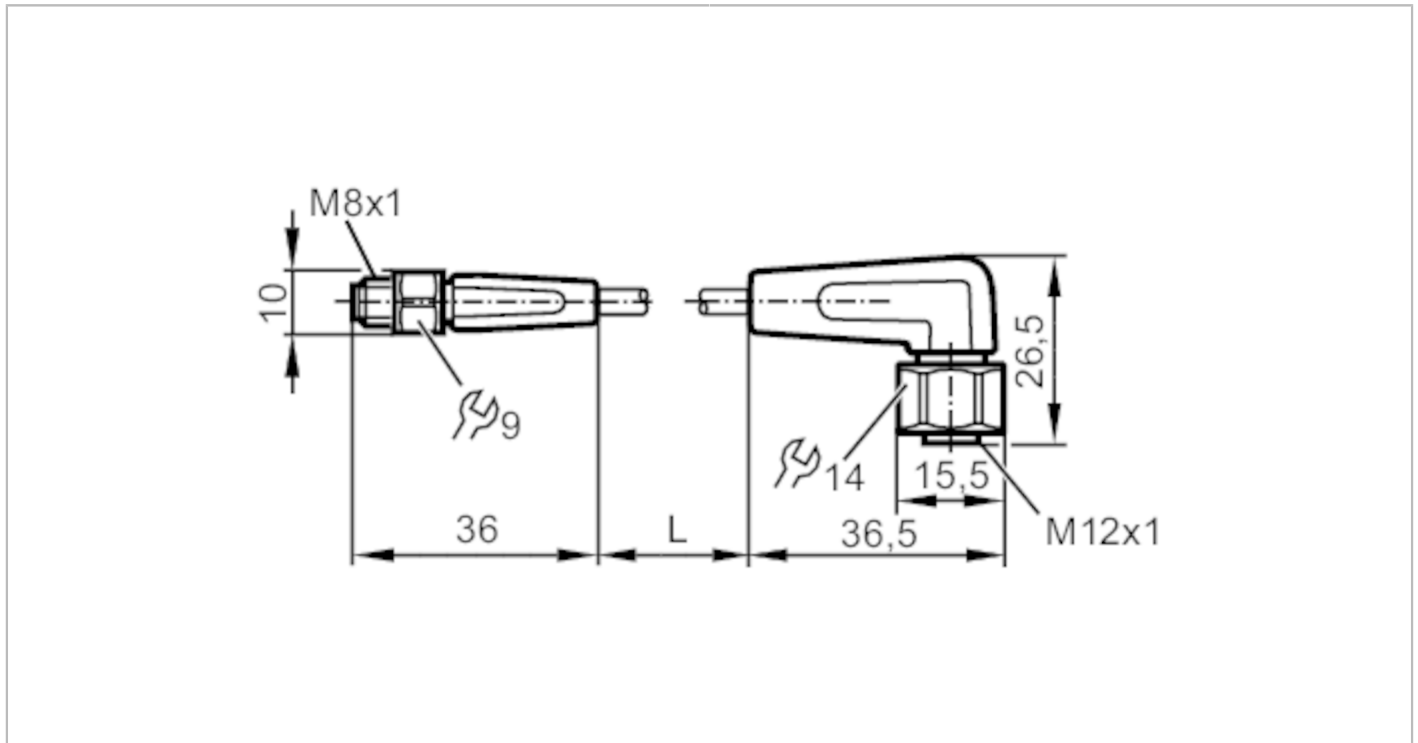

## Connection cable

VDOAH030VAS00,6P03STGF030VAS



Application		
Special feature	Free from silicone; Halogen-free; Gold-plated contacts; Drag chain suitability	
Application	hygienic and wet areas in the food industry	
Free from silicone	yes	
Electrical data		
Operating voltage [V]	< 50 AC / < 60 DC	
Protection class	III	
Max. current load total [A]	3	
Operating conditions		
Ambient temperature [°C]	-25...80	
Ambient temperature (moving) [°C]	5...80	
Protection	IP 65; IP 67; IP 68; IP 69K	
Mechanical data		
Weight [g]	41.2	
Dimensions [mm]	10 x 10 x 36	
Materials	housing: PP Halogen-free; Sealing: EPDM	
Material nut	stainless steel (1.4404 / 316L)	
Drag chain suitability	yes	
Drag chain suitability	bending radius for flexible use	min. 10 x cable diameter
	travel speed	max. 3.3 m/s for a horizontal travel length of 5 m and max. acceleration of 5 m/s <sup>2</sup>
	bending cycles	> 1 Mio.
	torsional strain	± 180 °/m

# EVF266



## Connection cable

VDOAH030VAS00,6P03STGF030VAS

### Remarks

Pack quantity

1 pcs.

### Electrical connection - plug

Connector: 1 x M8, straight; Locking: stainless steel (1.4404 / 316L); Contacts: gold-plated; Tightening torque: 0.3...0.5 Nm



### Electrical connection

Cable: 0.6 m, MPPE, Halogen-free, grey, Ø 4.9 mm; 3 x 0.34 mm<sup>2</sup> (42 x Ø 0.1 mm )

### Connection

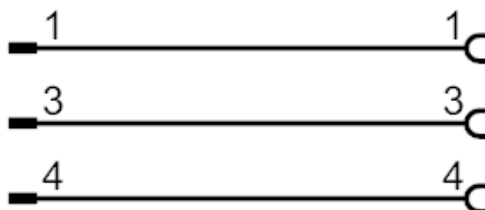

### Electrical connection - socket

Connector: 1 x M12, angled; Locking: stainless steel (1.4404 / 316L); Contacts: gold-plated; Tightening torque: 0.6...1.5 Nm

