

IF0161



Inductive sensor

IFA2002-ABOW/SL/ 6m

Article no longer available - archive entry

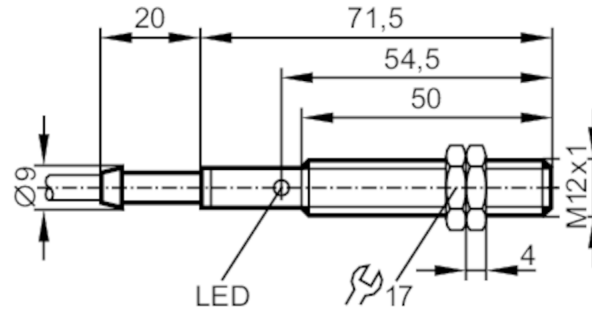

Product characteristics

Output function		normally open
Sensing range	[mm]	2
Housing		threaded type
Dimensions	[mm]	M12 x 1 / L = 71.5

Electrical data

Frequency AC	[Hz]	47...63
Operating voltage	[V]	90...250 AC
Protection class		II
Reverse polarity protection		no

Outputs

Output function		normally open
Max. voltage drop switching output AC	[V]	8.5
Minimum load current	[mA]	8
Max. leakage current	[mA]	3 (250 V AC) / 1.5 (120 V AC)
Permanent current rating of switching output AC	[mA]	200; (250 (...50 °C))
Short-time current rating of switching output	[mA]	900; (20 ms / 0,5 Hz)
Switching frequency AC	[Hz]	25
Short-circuit protection		no
Overload protection		no

Detection zone

Sensing range	[mm]	2
Real sensing range Sr	[mm]	2 ± 10 %
Operating distance	[mm]	0...1.6

Accuracy / deviations

Correction factor		steel: 1 / stainless steel: 0.7 / brass: 0.4 / aluminium: 0.3 / copper: 0.2
Hysteresis	[% of Sr]	1...15
Switch point drift	[% of Sr]	-10...10

IF0161



Inductive sensor

IFA2002-ABOW/SL/ 6m

Operating conditions		
Ambient temperature	[°C]	-25...80
Protection		IP 67
Mechanical data		
Housing		threaded type
Mounting		flush mountable
Dimensions	[mm]	M12 x 1 / L = 71.5
Thread designation		M12 x 1
Materials		brass nickel-plated; PBT
Displays / operating elements		
Display	switching status	1 x LED, yellow
Accessories		
Accessories (supplied)		lock nuts: 2
Remarks		
Pack quantity		1 pcs.
Electrical connection		
Cable: 6 m, PVC; 3 x 0.5 mm ²		
Connection		

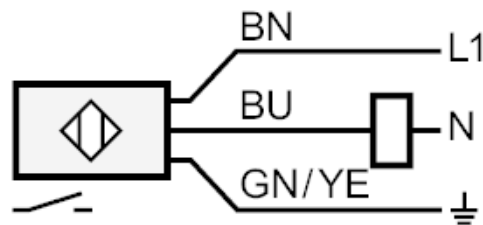

Core colours :

BN = brown

BU = blue

GN/YE = green/yellow

Article no longer available - archive entry