

DV1002

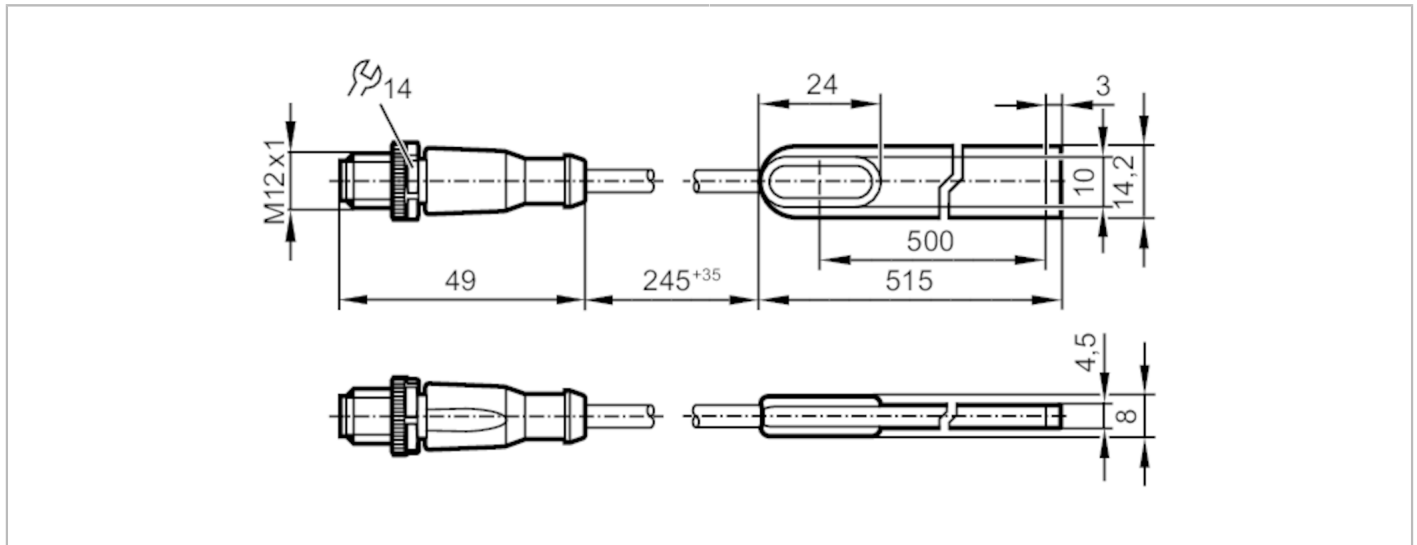

LED strip RGBW

LED-Stripe-RGBW-500mm-IP68



Application		
Application	signalling machine conditions	
Electrical data		
Operating voltage [V]	21.4...26.4 DC	
Nominal voltage DC [V]	24; (to SELV/PELV)	
Current consumption [mA]	800	
Colour temperature [K]	4000	
Luminous flux [lm]	red: 101.2 / green: 188.8 / blue: 37 / white: 285.2	
Note on luminous flux [lm]	luminous flux indications refer to one meter of LED strip	
Typ. lifetime [h]	30000	
Inputs		
Input circuit of digital inputs	24 V PNP	
Operating conditions		
Ambient temperature [°C]	-20...45	
Max. relative air humidity [%]	90	
Max. height above sea level [m]	4000	
Protection	IP 68	
Pollution degree	2	
Tests / approvals		
Approval	IEC 61471; IEC 62031	
Mechanical data		
Weight [g]	72.4	
Dimensions [mm]	515 x 14.2 x 4.5	
Materials	TPU	
Displays / operating elements		
Display	signalling machine conditions	LED, multi-colour RGB
	illumination of installations	LED, white

DV1002



LED strip RGBW

LED-Stripe-RGBW-500mm-IP68

Remarks

Pack quantity

1 pcs.

Electrical connection

Cable: 0.3 m

Connector: M12; coding: A

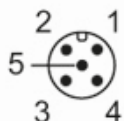

- | | |
|---|---------|
| 1 | + red |
| 2 | + green |
| 3 | GND |
| 4 | + white |
| 5 | + blue |

Diagrams and graphs

