

E60205

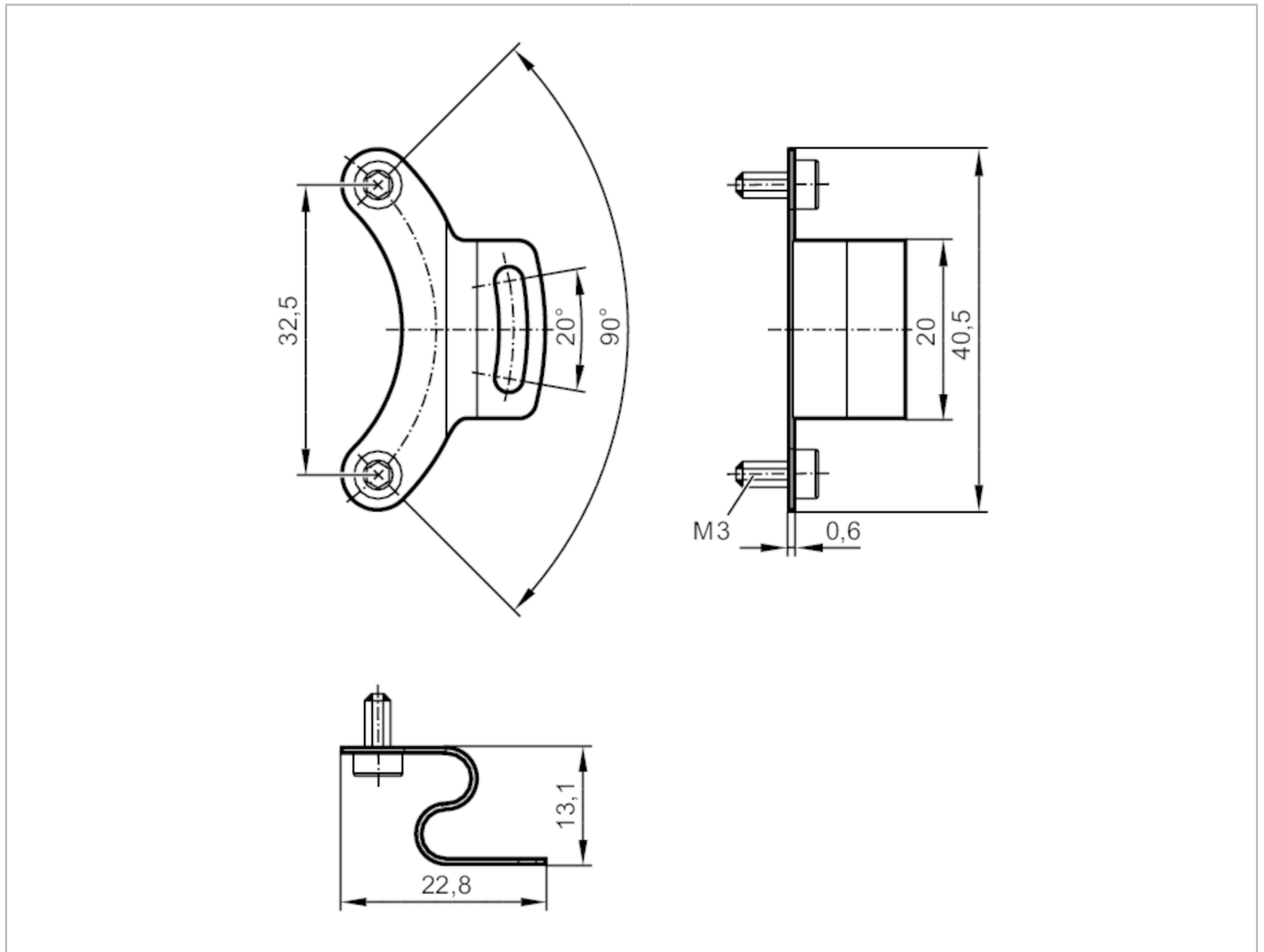

Stator coupling for encoders

STATOR COUPLING RO3, ROP



Mechanical data	
Weight [g]	7.5
Materials	stainless steel (1.4310 / 301)
Tightening torque [Nm]	0.8
Accessories	
Accessories (supplied)	socket head screws: 2 screw type: M3 x 0,5-6H, TX 10
Remarks	
Pack quantity	1 pcs.