

TA2135

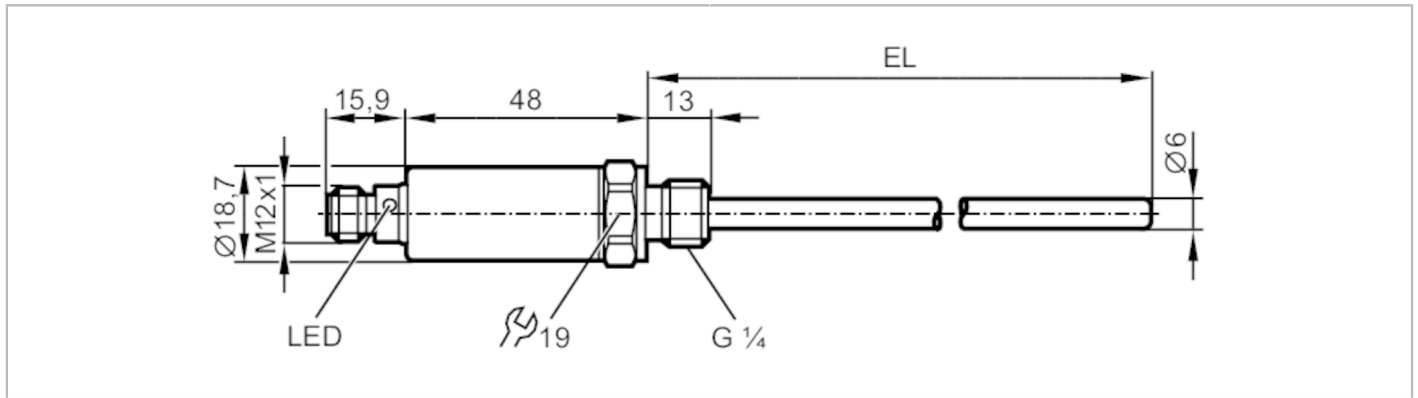

Temperature transmitter

TA-100CLER14-A-ZVG/US



Product characteristics

Number of inputs and outputs	Number of analogue outputs: 1
Measuring range [°C]	-50...150
Process connection	threaded connection G 1/4
Installation length EL [mm]	100

Application

Special feature	Gold-plated contacts
Measuring element	1 x Pt 1000; (to DIN EN 60751, class A)
Media	liquids and gases
Pressure rating [bar]	300
Note on pressure rating	sensor When mounted in adapters the specifications of the adapter data sheet apply.

Electrical data

Operating voltage [V]	18...32 DC; ("supply class 2" to cULus)
Current consumption [mA]	< 50
Protection class	III
Reverse polarity protection	yes
Power-on delay time [s]	1

Inputs / outputs

Number of inputs and outputs	Number of analogue outputs: 1
------------------------------	-------------------------------

Outputs

Total number of outputs	1
Output signal	analogue signal; IO-Link; (configurable)
Number of analogue outputs	1
Analogue current output [mA]	4...20
Max. load [Ω]	250; ((18...19 V); 19...32 V: 300 Ω)
Short-circuit protection	yes
Overload protection	yes

Measuring/setting range

Measuring range [°C]	-50...150
Factory setting	-50...150 °C

TA2135



Temperature transmitter

TA-100CLER14-A-ZVG/US

Resolution		
Resolution of analogue output [K]		0.04
Accuracy / deviations		
Precision analogue output [K]		$\pm 0,3 + (\pm 0,1 \% MS)$
Temperature coefficient [% of the span / 10 K]		0,1; (in case of deviation from the reference condition $25 \pm 5 \text{ }^\circ\text{C}$)
Response times		
Dynamic response T05 / T09 [s]		1 / 3
Interfaces		
Communication interface		IO-Link
Transmission type		COM2 (38,4 kBaud)
IO-Link revision		1.1
Operating conditions		
Ambient temperature [°C]		-25...80
Storage temperature [°C]		-40...100
Protection		IP 67; IP 68; IP 69K
Tests / approvals		
EMC	DIN EN 61000-6-2	
Shock resistance	DIN IEC 68-2-27	50 g (11 ms)
Vibration resistance	DIN IEC 68-2-6	20 g (10...2000 Hz)
MTTF [years]		572
UL approval	UL Approval no.	K002
Mechanical data		
Weight [g]		96
Dimensions [mm]		$\varnothing 18.7$
Materials		stainless steel (1.4404 / 316L); PEI; FKM
Materials (wetted parts)		stainless steel (1.4404 / 316L); O-ring: FKM
Tightening torque [Nm]		35
Process connection		threaded connection G 1/4
Probe diameter [mm]		6
Installation length EL [mm]		100
Displays / operating elements		
Display	operating status	1 x LED, green
Remarks		
Remarks		MS = set measuring span
Pack quantity		1 pcs.
Electrical connection		
Connector: 1 x M12; Contacts: gold-plated		

TA2135



Temperature transmitter

TA-100CLER14-A-ZVG/US



Connection

