

RP1316



Incremental encoder with hollow shaft

RP-3000-I05/N10

Article no longer available - archive entry

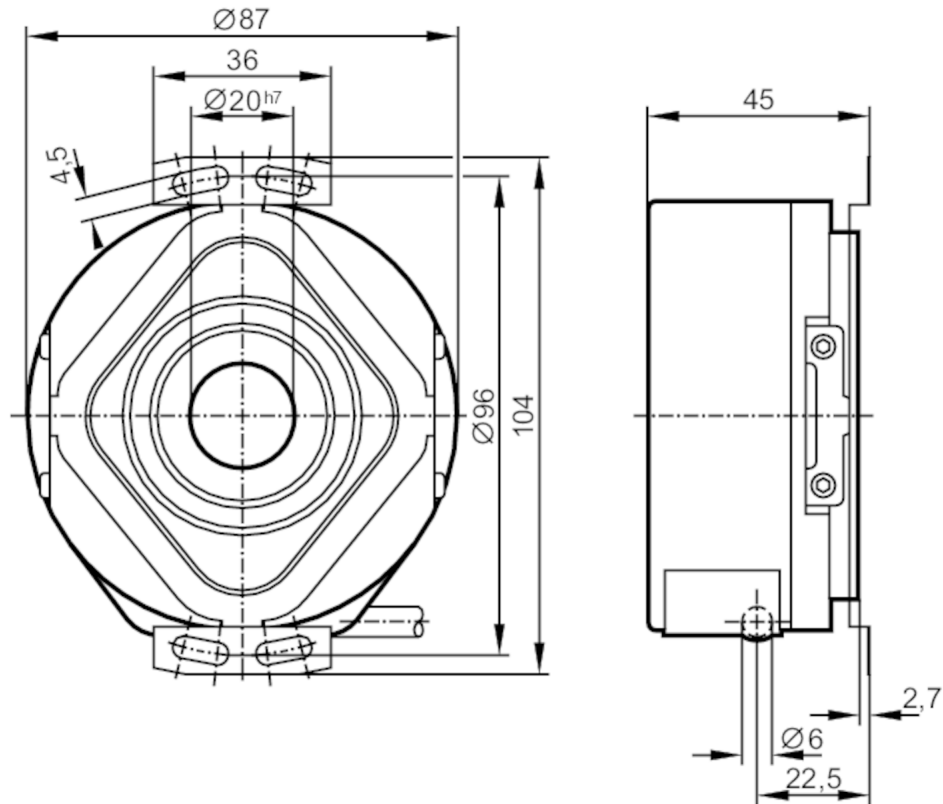

Product characteristics

Resolution	3000 resolution
Shaft design	continuous hollow shaft
Shaft diameter [mm]	20

Electrical data

Operating voltage tolerance [%]	10
Operating voltage [V]	5 DC
Current consumption [mA]	< 150

Outputs

Electrical design	TTL
Max. current load per output [mA]	20
Switching frequency [kHz]	300
Phase difference A and B [°]	90

Measuring/setting range

Resolution	3000 resolution
------------	-----------------

RP1316



Incremental encoder with hollow shaft

RP-3000-I05/N10

Operating conditions	
Ambient temperature [°C]	-30...60
Note on ambient temperature	higher temperature upon request for the diagram see the installation instructions
Storage temperature [°C]	-30...100
Max. relative air humidity [%]	98
Protection	IP 64

Tests / approvals	
Shock resistance	100 g (6 ms)
Vibration resistance	EN 60068-2-6 200 g (50...2000 Hz)

Mechanical data	
Dimensions [mm]	Ø 87 / L = 45
Materials	aluminium
Max. revolution, mechanical [U/min]	6000
Max. starting torque [Nm]	10
Reference temperature torque [°C]	20
Shaft design	continuous hollow shaft
Shaft diameter [mm]	20
Shaft fit	H7
Shaft material	steel (1.4104)
Installation depth of shaft [mm]	10
Max. axial shaft misalignment [mm]	1,5

Electrical connection	
Cable: 1 m, PUR; radial	

brown	A
green	A inverted
grey	B
pink	B inverted
red	0 index
black	0 index inverted
blue	L+ sensor
white	0V sensor
brown/green	L+ (Up)
white/green	0V (Un)
lilac	failure inverted
screen	housing

RP1316



Incremental encoder with hollow shaft

RP-3000-I05/N10

Diagrams and graphs

Pulse diagram

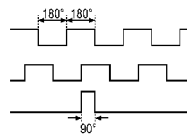

Output A

Output B

0 index