

# IF5340



## Inductive sensor

IFA3004-ANKG/20m

Article no longer available - archive entry

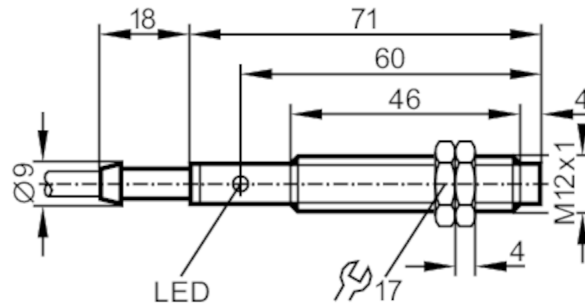

### Product characteristics

Electrical design		NPN
Output function		normally open
Sensing range	[mm]	4
Housing		threaded type
Dimensions	[mm]	M12 x 1 / L = 71

### Electrical data

Operating voltage	[V]	10...55 DC
Current consumption	[mA]	5; (24 V)
Protection class		II
Reverse polarity protection		yes

### Outputs

Electrical design		NPN
Output function		normally open
Max. voltage drop switching output DC	[V]	2.5
Permanent current rating of switching output DC	[mA]	250
Switching frequency DC	[Hz]	400
Short-circuit protection		yes
Type of short-circuit protection		pulsed
Overload protection		yes

### Detection zone

Sensing range	[mm]	4
Real sensing range Sr	[mm]	4 ± 10 %
Operating distance	[mm]	0...3.25

### Accuracy / deviations

Correction factor		steel: 1 / stainless steel: 0.7 / brass: 0.4 / aluminium: 0.3 / copper: 0.2
Hysteresis	[% of Sr]	1...15
Switch point drift	[% of Sr]	-10...10

# IF5340



## Inductive sensor

IFA3004-ANKG/20m

Operating conditions		
Ambient temperature	[°C]	-25...80
Protection		IP 67
Mechanical data		
Housing		threaded type
Mounting		non-flush mountable
Dimensions	[mm]	M12 x 1 / L = 71
Thread designation		M12 x 1
Materials		brass nickel-plated; PBT
Displays / operating elements		
Display	switching status	1 x LED, yellow
Accessories		
Items supplied		lock nuts: 2
Remarks		
Pack quantity		1 pcs.
Electrical connection		
Cable: 20 m, PVC; 3 x 0.34 mm <sup>2</sup>		
Connection		

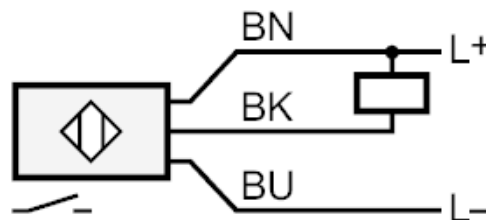

Core colours :

BN =	brown
BU =	blue
BK =	black