

EVF498

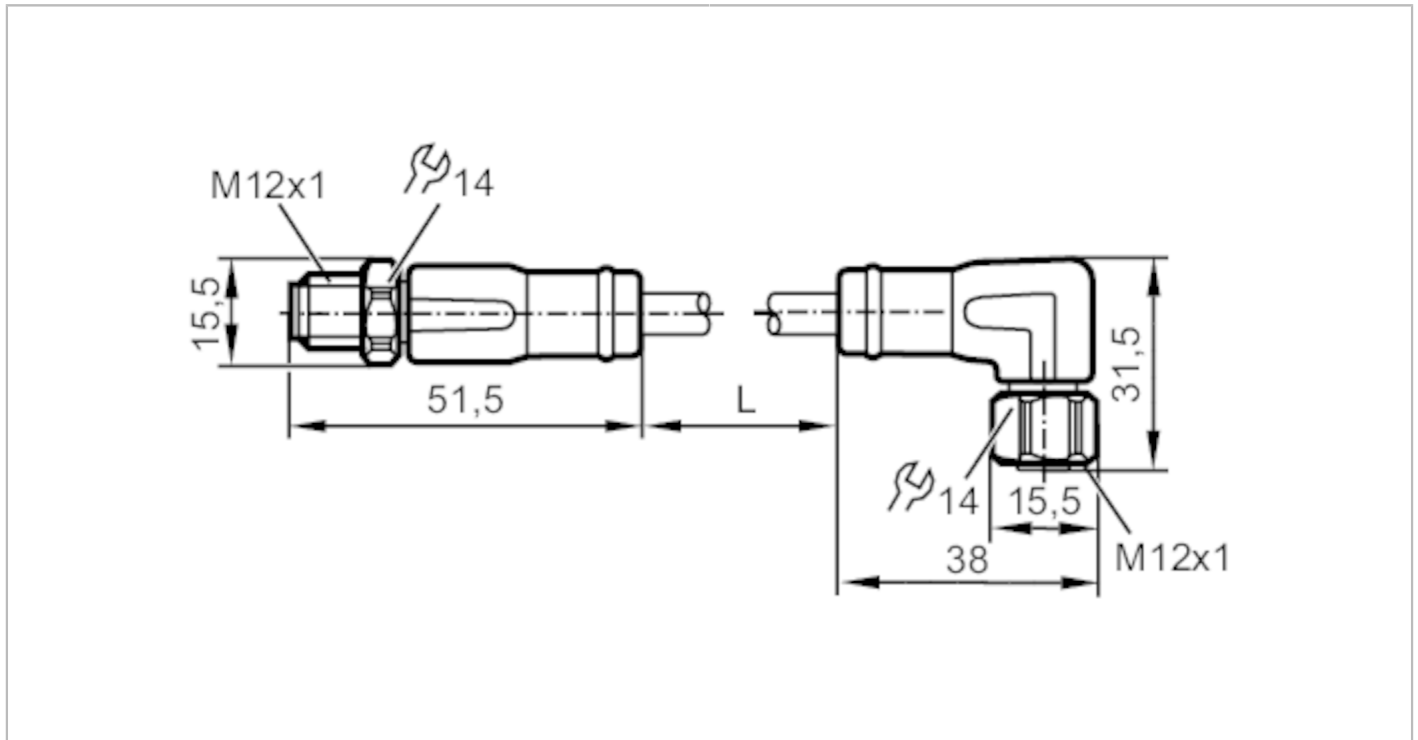

Connection cable

VDOAH040VAP00,5P04STGH040VAP



Application	
Special feature	Free from silicone; Halogen-free; Gold-plated contacts; Drag chain suitability
Application	hygienic and wet areas in the food industry
Free from silicone	yes
Electrical data	
Operating voltage [M]	< 250 AC / < 300 DC
Protection class	II
Max. current load total [A]	4
Operating conditions	
Ambient temperature [°C]	-25...100
Ambient temperature (moving) [°C]	0...100
Storage temperature [°C]	-25...55
Storage humidity [%]	10...100
Other climatic conditions for storage according to stated class	1K22/ DIN 60721-3-1
Protection	IP 65; IP 67; IP 68; IP 69K

EVF498



Connection cable

VDOAH040VAP00,5P04STGH040VAP

Mechanical data		
Weight [g]	66.7	
Materials	PP Halogen-free; Sealing: EPDM	
Moulded-body material	PP, Halogen-free	
Material nut	stainless steel (1.4404 / 316L)	
Drag chain suitability	yes	
Drag chain suitability	bending radius for flexible use	min. 10 x cable diameter
	travel speed	max. 3.3 m/s for a horizontal travel length of 5 m and max. acceleration of 5 m/s ²
	bending cycles	> 1 Mio.
	torsional strain	± 180 °/m

Remarks

Pack quantity	1 pcs.
---------------	--------

Electrical connection - plug

Connector: 1 x M12, straight; Moulded body: PP, Halogen-free; Locking: stainless steel (1.4404 / 316L); Contacts: gold-plated; Tightening torque: 0.6...1.2 Nm



Electrical connection

Cable: 0.5 m, MPPE, Halogen-free, grey, Ø 6.2 mm; 4 x 1.00 mm² (32 x Ø 0.2 mm)

Connection

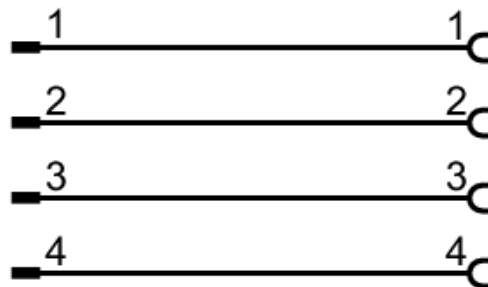

Electrical connection - socket

Connector: 1 x M12, angled; Moulded body: PP, Halogen-free; Locking: stainless steel (1.4404 / 316L); Contacts: gold-plated; Tightening torque: 0.6...1.5 Nm

EVF498



Connection cable

VDOAH040VAP00,5P04STGH040VAP

