

TA2313

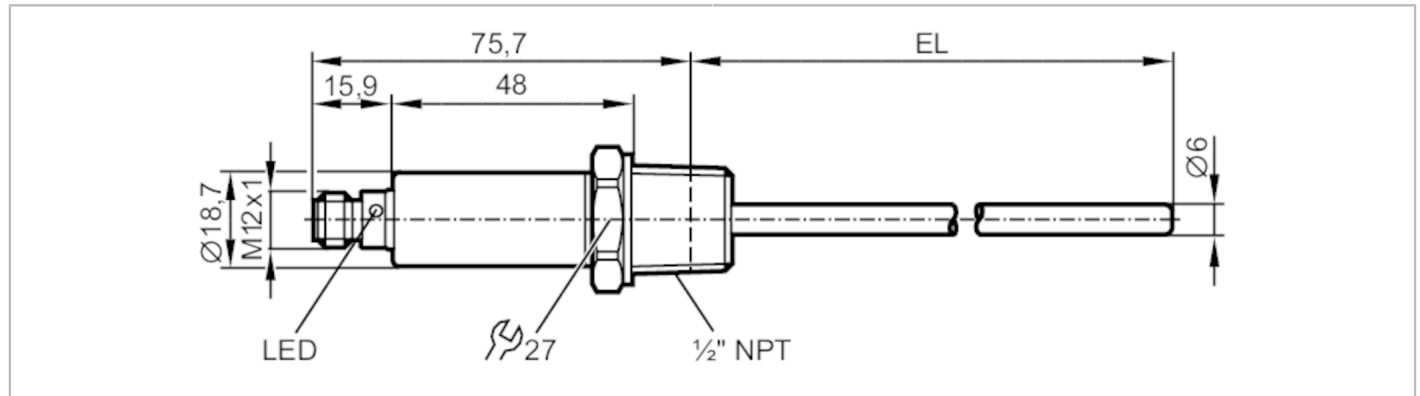

Temperature transmitter

TA-050FLEN12-A-ZVG/US



Product characteristics

Number of inputs and outputs	Number of analogue outputs: 1
Measuring range [°F]	-58...302
Communication interface	IO-Link
Process connection	threaded connection 1/2" NPT external thread
Installation length EL [mm]	50

Application

Special feature	Gold-plated contacts
Measuring element	1 x Pt 1000; (to DIN EN 60751, class A)
Media	liquids and gases
Pressure rating	300 bar 30 MPa
Note on pressure rating	sensor
	When mounted in adapters the specifications of the adapter data sheet apply.
MAWP for applications according to CRN [bar]	300

Electrical data

Operating voltage [V]	18...32 DC; ("supply class 2" to cULus)
Current consumption [mA]	< 50
Protection class	III
Reverse polarity protection	yes
Power-on delay time [s]	1

Inputs / outputs

Number of inputs and outputs	Number of analogue outputs: 1
------------------------------	-------------------------------

Outputs

Total number of outputs	1
Output signal	analogue signal; IO-Link; (configurable)
Number of analogue outputs	1
Analogue current output [mA]	4...20
Max. load [Ω]	250; ((18...19 V); 19...32 V: 300 Ω)
Short-circuit protection	yes
Overload protection	yes

TA2313



Temperature transmitter

TA-050FLEN12-A-ZVG/US

Measuring/setting range		
Probe length L	[mm]	46.8
Measuring range	[°F]	-58...302
Factory setting		0...300 °F
Resolution		
Resolution of analogue output	[K]	0.04
Accuracy / deviations		
Precision analogue output	[K]	± 0,3 + (± 0,1 % MS)
Temperature coefficient [% of the span / 10 K]		0,1; (in case of deviation from the reference condition 25 ± 5 °C)
Response times		
Dynamic response T05 / T09	[s]	1 / 3
Interfaces		
Communication interface		IO-Link
Transmission type		COM2 (38,4 kBaud)
IO-Link revision		1.1
Profiles	Smart Sensor - SSP 0	Generic Profiled Sensor
	Function	Device identification
	Function	Process data variable
Min. process cycle time	[ms]	2.3
Supported DeviceIDs	Type of operation default	DeviceID 378
Operating conditions		
Ambient temperature	[°C]	-25...80
Storage temperature	[°C]	-40...100
Protection		IP 67; IP 68; IP 69K
Tests / approvals		
EMC	DIN EN 61000-6-2	
Shock resistance	DIN IEC 68-2-27	50 g (11 ms)
Vibration resistance	DIN IEC 68-2-6	20 g (10...2000 Hz)
MTTF	[years]	572
UL approval	UL approval no.	K002
Mechanical data		
Weight	[g]	132.5
Housing		cylindrical
Dimensions	[mm]	Ø 18.7 / L = 125.7
Materials		stainless steel (316L/1.4404); PEI; FKM
Materials (wetted parts)		stainless steel (316L/1.4404)
Process connection		threaded connection 1/2" NPT external thread
Probe diameter	[mm]	6
Installation length EL	[mm]	50
Displays / operating elements		
Display	operating status	1 x LED, green

TA2313



Temperature transmitter

TA-050FLEN12-A-ZVG/US

Remarks

Remarks	MS = set measuring span
Pack quantity	1 pcs.

Electrical connection

Connector: 1 x M12; coding: A; Contacts: gold-plated

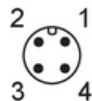

Connection

