

EVC242



Connection cable

VDOGF040MSS0001H04STGH040MSS

Please see the technical note under "Downloads"

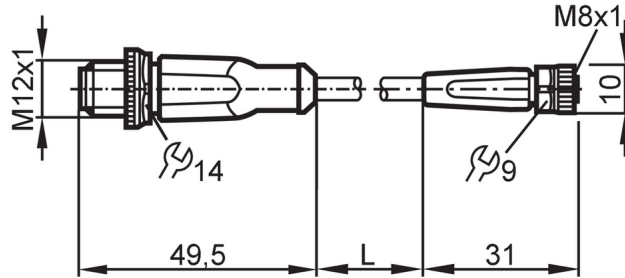

Application		
Special feature	Free from silicone; Halogen-free; Gold-plated contacts; Drag chain suitability	
Free from silicone	yes	
Electrical data		
Operating voltage [V]	< 50 AC / < 60 DC	
Protection class	III	
Max. current load total [A]	3	
Operating conditions		
Ambient temperature [°C]	-25...90	
Note on ambient temperature	cULus: ...75 °C	
Ambient temperature (moving) [°C]	-25...90	
Note on ambient temperature (moving)	cULus: ...75 °C	
Protection	IP 65; IP 67; IP 68; IP 69K	
Mechanical data		
Weight [g]	58.5	
Moulded-body material	TPU	
Material nut	brass, nickel-plated	
Sealing material	FKM	
Drag chain suitability	yes	
Drag chain suitability	bending radius for flexible use	min. 10 x cable diameter
	travel speed	max. 3.3 m/s for a horizontal travel length of 5 m and max. acceleration of 5 m/s ²
	bending cycles	> 5 Mio.
	torsional strain	± 180 °/m
Remarks		
Notes	Please see the technical note under "Downloads"	
Pack quantity	1 pcs.	

EVC242



Connection cable

VDOGF040MSS0001H04STGH040MSS

Electrical connection - plug

Connector: 1 x M12, straight; coding: A; Contacts: 4, gold-plated; Moulded body: TPU, orange; Locking: brass, nickel-plated; Tightening torque: 0.6...1.5 Nm



Electrical connection

Cable: 1 m, PUR, Halogen-free, black, Ø 4.3 mm; 4 x 0.34 mm² (42 x Ø 0.1 mm)

Connection

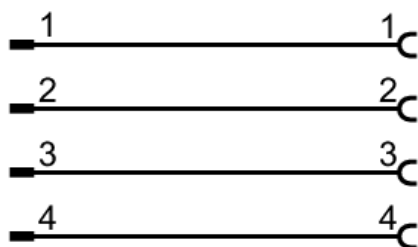

Electrical connection - socket

Connector: 1 x M8, straight; coding: A; Contacts: 4, gold-plated; Moulded body: TPU, orange; Locking: brass, nickel-plated; Sealing: FKM; Tightening torque: 0.3...0.5 Nm





Connection cable

VDOGF040MSS0001H04STGH040MSS

Diagrams and graphs

characteristic line for derating

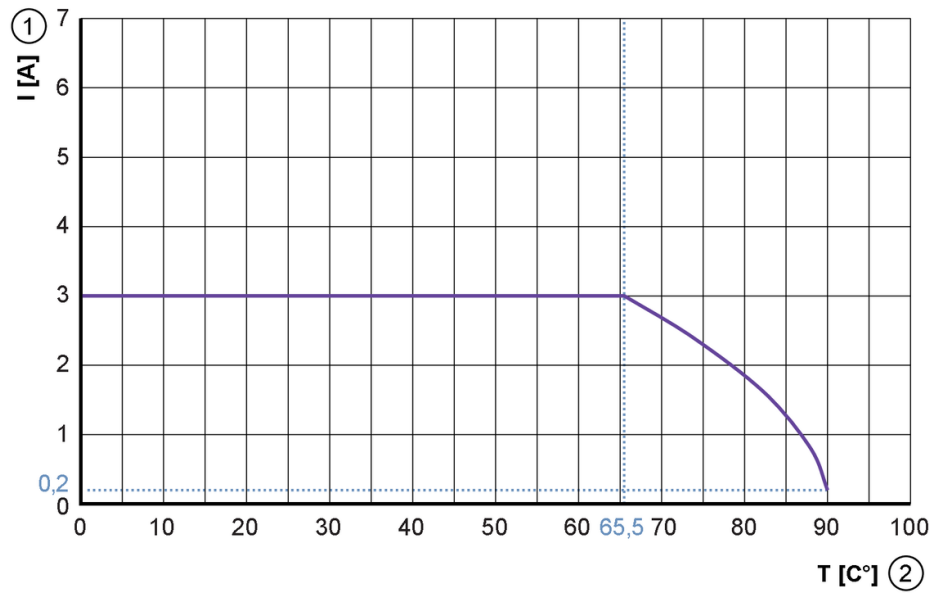

- 1 Current [A]
- 2 Ambient temperature [°C]