

EVC088



Connecting cable with socket

ADOAH040MSS0025H04

Please see the technical note under "Downloads"

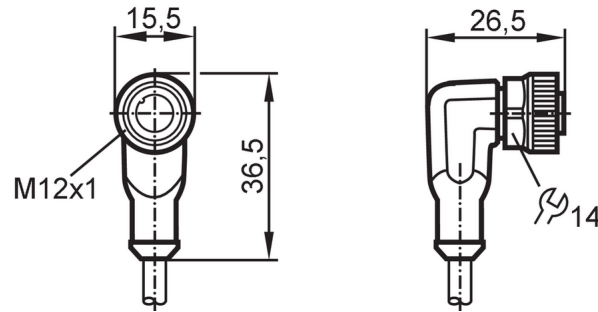

Application									
Special feature	Free from silicone; Halogen-free; Gold-plated contacts; Drag chain suitability								
Application	Industrial applications / factory automation; Use in machine tools, coolants and lubricants								
Free from silicone	yes								
Electrical data									
Operating voltage [V]	< 250 AC / < 300 DC								
Protection class	II								
Max. current load total [A]	4								
Operating conditions									
Ambient temperature [°C]	-25...90								
Note on ambient temperature	cULus: ...75								
Ambient temperature (moving) [°C]	-25...90								
Note on ambient temperature (moving)	cULus: ...75								
Storage temperature [°C]	-25...55								
Storage humidity [%]	10...100								
Other climatic conditions for storage according to stated class	1K22/ DIN 60721-3-1								
Protection	IP 65; IP 67; IP 68; IP 69K								
Mechanical data									
Weight [g]	678.1								
Dimensions [mm]	26.5 x 15.5 x 36.5								
Moulded-body material	TPU								
Material nut	brass, nickel-plated								
Sealing material	FKM								
Drag chain suitability	yes								
Drag chain suitability	<table border="1"> <tr> <td>bending radius for flexible use</td> <td>min. 10 x cable diameter</td> </tr> <tr> <td>travel speed</td> <td>max. 3.3 m/s for a horizontal travel length of 5 m and max. acceleration of 5 m/s²</td> </tr> <tr> <td>bending cycles</td> <td>> 5 Mio.</td> </tr> <tr> <td>torsional strain</td> <td>± 180 °/m</td> </tr> </table>	bending radius for flexible use	min. 10 x cable diameter	travel speed	max. 3.3 m/s for a horizontal travel length of 5 m and max. acceleration of 5 m/s ²	bending cycles	> 5 Mio.	torsional strain	± 180 °/m
bending radius for flexible use	min. 10 x cable diameter								
travel speed	max. 3.3 m/s for a horizontal travel length of 5 m and max. acceleration of 5 m/s ²								
bending cycles	> 5 Mio.								
torsional strain	± 180 °/m								

EVC088



Connecting cable with socket

ADOAH040MSS0025H04

Remarks	
Notes	Please see the technical note under "Downloads"
Pack quantity	1 pcs.

Electrical connection
 Cable: 25 m, PUR, Halogen-free, black, Ø 4.3 mm; 4 x 0.34 mm² (42 x Ø 0.1 mm)

Electrical connection - socket
 Connector: 1 x M12, angled; coding: A; Contacts: 4, gold-plated; Moulded body: TPU, orange; Locking: brass, nickel-plated;
 Sealing: FKM; Tightening torque: 0.6...1.5 Nm

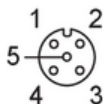

Connection

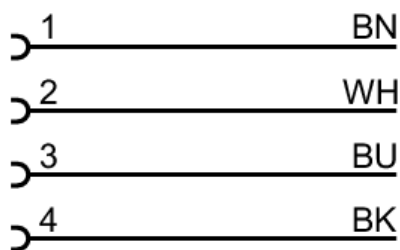

Core colours :
 BK = black
 BN = brown
 BU = blue
 WH = white

Diagrams and graphs

characteristic line for derating

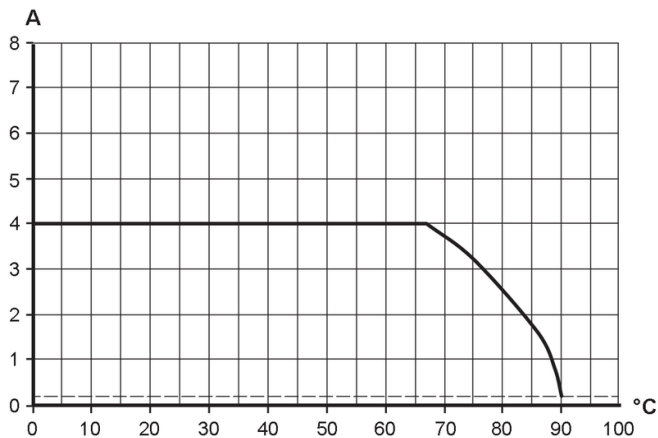

Derating $I_{max} * 0.8$ (DIN EN 60512-5-2)

X Ambient temperature [°C]
 Y Current [A]