

EVC019



Connection cable

VDOAH040MSS0005H04STGH040MSS

Please see the technical note under "Downloads"

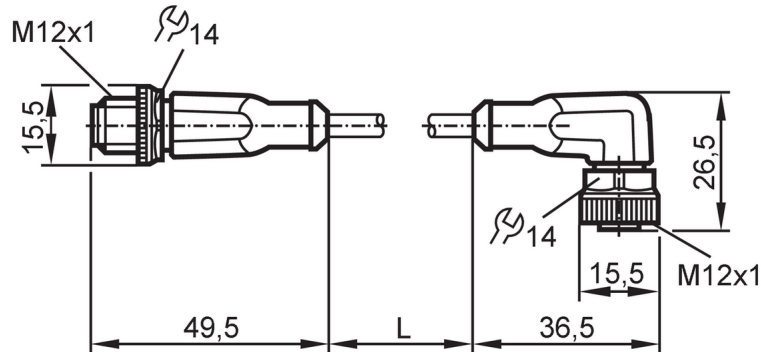

Application

Special feature	Free from silicone; Halogen-free; Gold-plated contacts; Drag chain suitability
Application	Industrial applications / factory automation; Use in machine tools, coolants and lubricants
Free from silicone	yes

Electrical data

Operating voltage	[V]	< 250 AC / < 300 DC
Protection class		II
Max. current load total	[A]	4

Operating conditions

Ambient temperature	[°C]	-25...90
Note on ambient temperature		cULus: ...75
Ambient temperature (moving)	[°C]	-25...90
Note on ambient temperature (moving)		cULus: ...75
Storage temperature	[°C]	-25...55
Storage humidity	[%]	10...100
Other climatic conditions for storage according to stated class		1K22/ DIN 60721-3-1
Protection		IP 65; IP 67; IP 68; IP 69K

Mechanical data

Weight	[g]	167.7
Moulded-body material		TPU
Material nut		brass, nickel-plated
Sealing material		FKM
Drag chain suitability		yes
Drag chain suitability	bending radius for flexible use	min. 10 x cable diameter
	travel speed	max. 3.3 m/s for a horizontal travel length of 5 m and max. acceleration of 5 m/s ²
	bending cycles	> 5 Mio.
	torsional strain	± 180 °/m

EVC019



Connection cable

VDOAH040MSS0005H04STGH040MSS

Remarks

Notes	Please see the technical note under "Downloads"
Pack quantity	1 pcs.

Electrical connection - plug

Connector: 1 x M12, straight; coding: A; Contacts: 4, gold-plated; Moulded body: TPU, orange; Locking: brass, nickel-plated; Tightening torque: 0.6...1.5 Nm



Electrical connection

Cable: 5 m, PUR, Halogen-free, black, Ø 4.3 mm; 4 x 0.34 mm² (42 x Ø 0.1 mm)

Connection

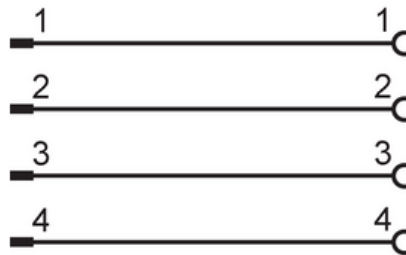

Electrical connection - socket

Connector: 1 x M12, angled; coding: A; Contacts: 4, gold-plated; Moulded body: TPU, orange; Locking: brass, nickel-plated; Sealing: FKM; Tightening torque: 0.6...1.5 Nm

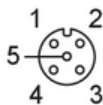

Diagrams and graphs

characteristic line for derating

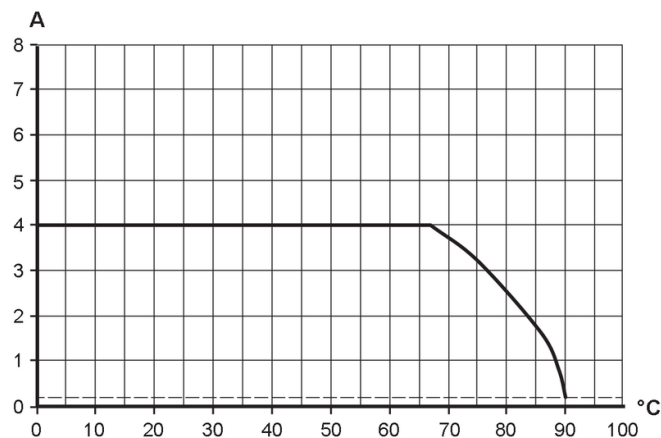

Derating $I_{max} * 0.8$ (DIN EN 60512-5-2)

X Ambient temperature [°C]

Y Current [A]