

DV1002



LED strip RGBW

LED-Stripe-RGBW-500mm-IP68

phase-out article

Alternative articles: DV1100

When selecting an alternative article and accessories please note that technical data may differ!

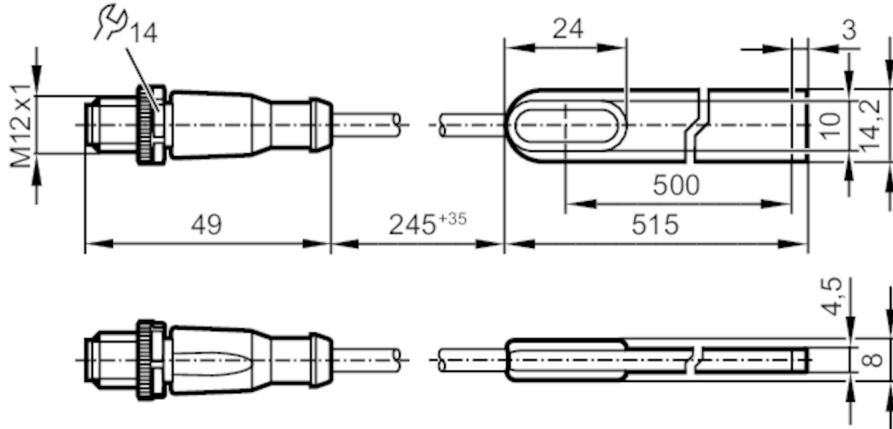

Application

Application

signalling machine conditions

Electrical data

Operating voltage	[V]	21.4...26.4 DC
Nominal voltage DC	[V]	24; (to SELV/PELV)
Current consumption	[mA]	800
Colour temperature	[K]	4000
Luminous flux	[lm]	red: 101.2; green: 188.8; blue: 37; white: 285.2
Note on luminous flux	[lm]	luminous flux indications refer to one meter of LED strip
Typ. lifetime	[h]	30000

Inputs

Input circuit of digital inputs	24 V PNP
---------------------------------	----------

Operating conditions

Ambient temperature	[°C]	-20...45
Max. relative air humidity	[%]	90
Max. height above sea level	[m]	4000
Protection		IP 68
Pollution degree		2

Tests / approvals

Approval	IEC 62471; IEC 62031
----------	----------------------

Mechanical data

Weight	[g]	72.4
Dimensions	[mm]	515 x 14.2 x 4.5

DV1002



LED strip RGBW

LED-Stripe-RGBW-500mm-IP68

Materials	TPU
-----------	-----

Displays / operating elements

Display	signalling machine conditions	LED, multi-colour RGB
	mounting light	LED, white

Remarks

Pack quantity	1 pcs.
---------------	--------

Electrical connection

Cable: 0.3 m

Connector: M12; coding: A

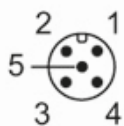

- 1 + red
- 2 + green
- 3 GND
- 4 + white
- 5 + blue

Diagrams and graphs

