

OY437S

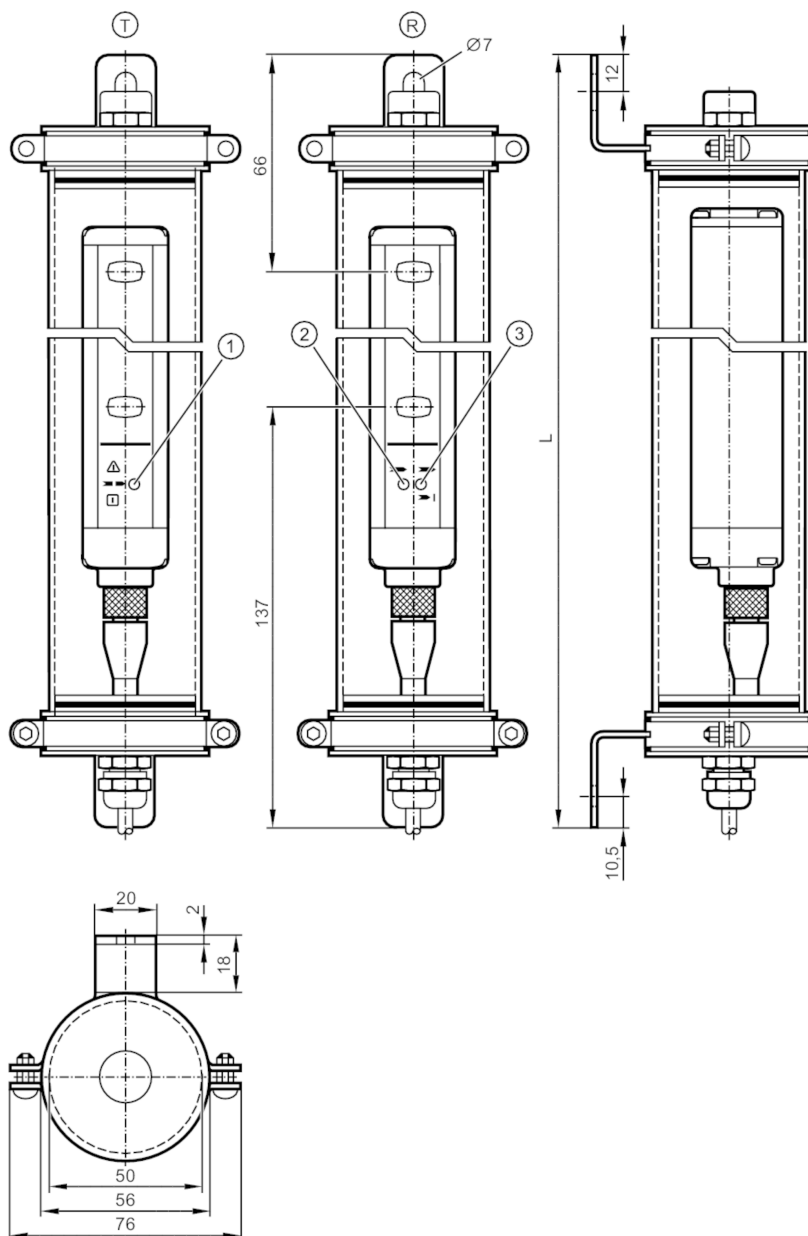

Safety light curtain

OYA1060-30-2-09-P-1-A



- T transmitter
- R receiver
- 1 LED three-colour red / green / orange
- 2 LED 2-colour yellow/blue
- 3 LED 2-colour red/green



Product characteristics

Type of light	infrared light
Dimensions [mm]	Ø 56

Application

Protective function	access prevention hand protection
---------------------	-----------------------------------



Safety light curtain

OYA1060-30-2-09-P-1-A

Electrical data		
Operating voltage tolerance	[%]	20
Operating voltage	[V]	24 DC
Protection class		III
Reverse polarity protection		yes
Power-on delay time	[s]	< 2
Type of light		infrared light
Wave length	[nm]	950
Receiver		
Current consumption	[mA]	83
Current consumption heating	[mA]	417
Transmitter		
Current consumption	[mA]	42
Current consumption heating	[mA]	417
Outputs		
Electrical design		PNP
Number of OSSD outputs		2
Max. current load per OSSD output	[mA]	400; (24 V)
Short-circuit protection		yes
Detection zone		
Protected area height	[mm]	1060
Resolution (detection capacity d)	[mm]	30
Protection area width (low light intensity)	[m]	0...3
Protection area width (high light intensity)	[m]	2...10
Response times		
Response time	[ms]	14.5
Operating conditions		
Ambient temperature	[°C]	-20...55
Max. relative air humidity	[%]	95
Protection		IP 65; IP 67; IP 69K; (with protective tube: IP 69K)
Tests / approvals		
EMC		IEC 61496-1
Shock resistance		IEC 61496-1
Vibration resistance		IEC 61496-1
Safety classification		
ESPE type (IEC 61496-1)		2
ISO 13849-1		category 2, PL c
IEC 62061		SIL cl 1
Mission time TM	[h]	175200
Safety-related reliability PFHD	[1/h]	5.8E-08

OY437S



Safety light curtain

OYA1060-30-2-09-P-1-A

Mechanical data		
Weight	[g]	6560
Dimensions	[mm]	Ø 56
Materials	thermowell: PMMA transparent; Protective cap: POM; clamp: stainless steel (1.4404 / 316L); Sealing: silicone	
Length L	[mm]	1237
Displays / operating elements		
Display	transmitter	1 LED
	receiver	2 LED
Remarks		
Pack quantity	1 pcs.	



Safety light curtain

OYA1060-30-2-09-P-1-A

Electrical connection - receiver

Cable: 15 m, PVC; Maximum cable length: 100 m; 10 x 0.34 mm²

Connection



1: heating

Core colours :

BK =	black
BN =	brown
BU =	blue
GN =	green
GY =	grey
PK =	pink
RD =	red
VT =	lilac
WH =	white
YE =	yellow

OY437S



Safety light curtain

OYA1060-30-2-09-P-1-A

Electrical connection - transmitter

Cable: 15 m, PVC; 8 x 0.34 mm²

Connection

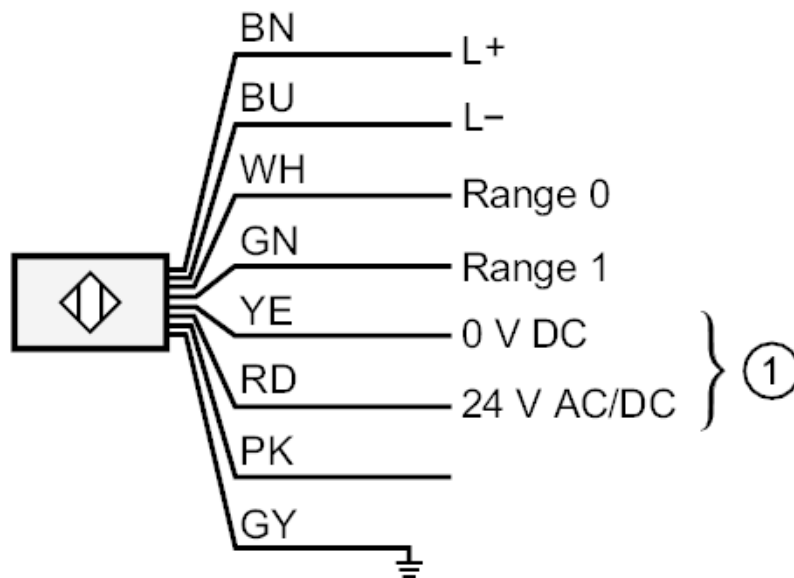

1: heating

PK: not used

Core colours :

BN = brown

BU = blue

GN = green

GY = grey

PK = pink

RD = red

WH = white

YE = yellow