

# EVT267

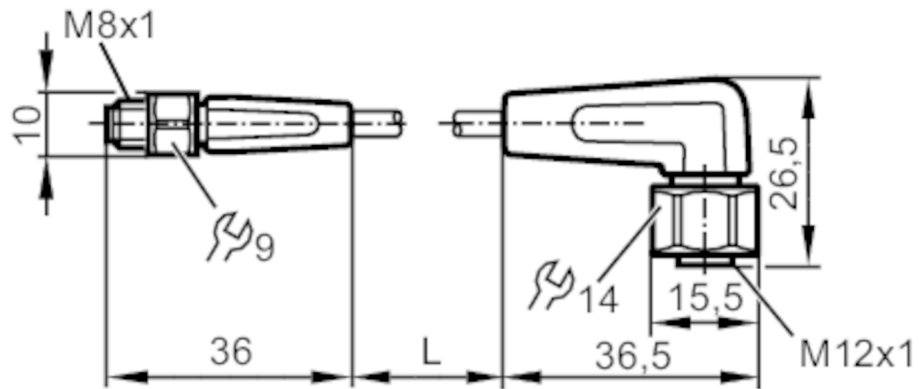

## Connection cable

VDOAH030VAS0001E03STGF030VAS



### Application

Special feature	Free from silicone; Gold-plated contacts; Drag chain suitability
Application	hygienic and wet areas in the food industry
Free from silicone	yes

### Electrical data

Operating voltage	[V]	< 50 AC / < 60 DC
Protection class		III
Max. current load total	[A]	3

### Operating conditions

Ambient temperature	[°C]	-25...80
Note on ambient temperature		cULus: ...50
Ambient temperature (moving)	[°C]	5...80
Note on ambient temperature (moving)		cULus: ...50
Protection		IP 65; IP 67; IP 68; IP 69K

# EVT267



## Connection cable

VDOAH030VAS0001E03STGF030VAS

Mechanical data		
Weight [g]	58.8	
Dimensions [mm]	10 x 10 x 36	
Materials	housing: PVC orange; Sealing: EPDM	
Material nut	stainless steel (1.4404 / 316L) / stainless steel (1.4404 / 316L)	
Drag chain suitability	yes	
Drag chain suitability	bending radius for flexible use	min. 10 x cable diameter
	travel speed	max. 3.3 m/s for a horizontal travel length of 5 m and max. acceleration of 5 m/s <sup>2</sup>
	bending cycles	> 1 Mio.
	torsional strain	± 180 °/m

## Remarks

Pack quantity	1 pcs.
---------------	--------

## Electrical connection - plug

Connector: 1 x M8, straight; Locking: stainless steel (1.4404 / 316L); Contacts: gold-plated; Tightening torque: 0.3...0.5 Nm



## Electrical connection

Cable: 1 m, PVC, orange, Ø 4.9 mm; 3 x 0.34 mm<sup>2</sup> (42 x Ø 0.1 mm)

## Connection



## Electrical connection - socket

Connector: 1 x M12, angled; Locking: stainless steel (1.4404 / 316L); Contacts: gold-plated; Tightening torque: 0.6...1.5 Nm

# EVT267



## Connection cable

VDOAH030VAS0001E03STGF030VAS

