

E10615



Connecting cable with socket

ADOAF032ZDS0005A03

Article no longer available - archive entry



Electrical data

Operating voltage	[V]	10...30 DC
Protection class		III

Outputs

Electrical design	PNP
-------------------	-----

Operating conditions

Ambient temperature	[°C]	-25...90
Protection		IP 67

Mechanical data

Dimensions	[mm]	17 x 10 x 26
Materials		PUR
Material nut		diecast zinc

Displays / operating elements

Display	switching status	1 x LED, yellow
	operation	1 x LED, green

Remarks

Pack quantity	1 pcs.
---------------	--------

Electrical connection

Cable: 5 m, PUR / PVC, black, Ø 5 mm; 3 x 0.34 mm² (42 x Ø 0.1 mm)

Electrical connection - socket

Connector: 1 x M8, angled; Moulded body: PUR; Locking: diecast zinc

E10615



Connecting cable with socket

ADOAF032ZDS0005A03

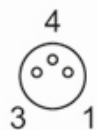

Connection

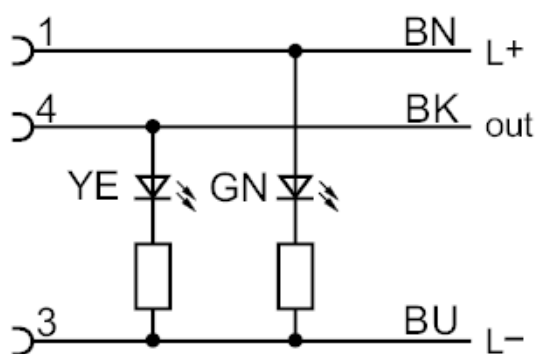

Core colours :

BN =

brown

BK =

black

BU =

blue

Article no longer available - archive entry