

SF0705



Flow sensor for connection to an evaluation unit

SFR14ABBE1

Article no longer available - archive entry

replaced by: SF221A

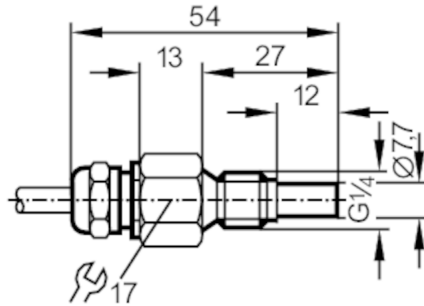

Product characteristics

Process connection G 1/4 external thread

Application

Application Ex zone 1
 Medium temperature [°C] -25...80
 Pressure rating [bar] 30

Liquids

Application Ex zone 1
 Medium temperature [°C] -25...80

Gases

Medium temperature [°C] -25...80

Electrical data

Connection to control monitor VS 0200 Exi

Measuring/setting range

Liquids

Setting range [cm/s] 3...300
 Greatest sensitivity [cm/s] 3...60

Gases

Setting range [cm/s] 200...2000
 Greatest sensitivity [cm/s] 200...800

Accuracy / deviations

Temperature gradient [K/min] 15

Response times

Response time [s] 1...10

Liquids

Response time [s] 1...10

Gases

Response time [s] 1...10

Operating conditions

Protection IP 67

SF0705



Flow sensor for connection to an evaluation unit

SFR14ABBE1

Mechanical data	
Housing	threaded type
Materials	stainless steel (1.4571/316Ti)
Materials (wetted parts)	stainless steel (1.4571/316Ti)
Process connection	G 1/4 external thread

Remarks	
Pack quantity	1 pcs.

Electrical connection	
Cable: 2 m, TPE-S; Maximum cable length: 100 m; 5 x 0.34 mm ²	

Connection

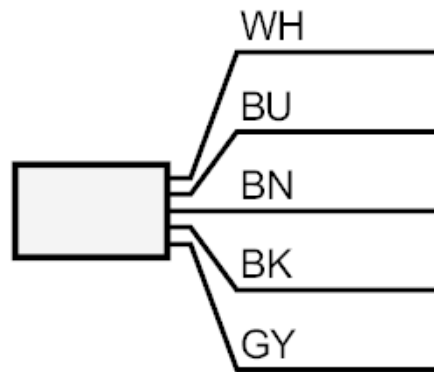

	Core colours :
BN =	brown
BU =	blue
BK =	black
WH =	white
GY =	grey

Article no longer available - archive entry

replaced by: SF221A