

RU1174



Incremental encoder with solid shaft

RU-1750-I05/N2

Article no longer available - archive entry

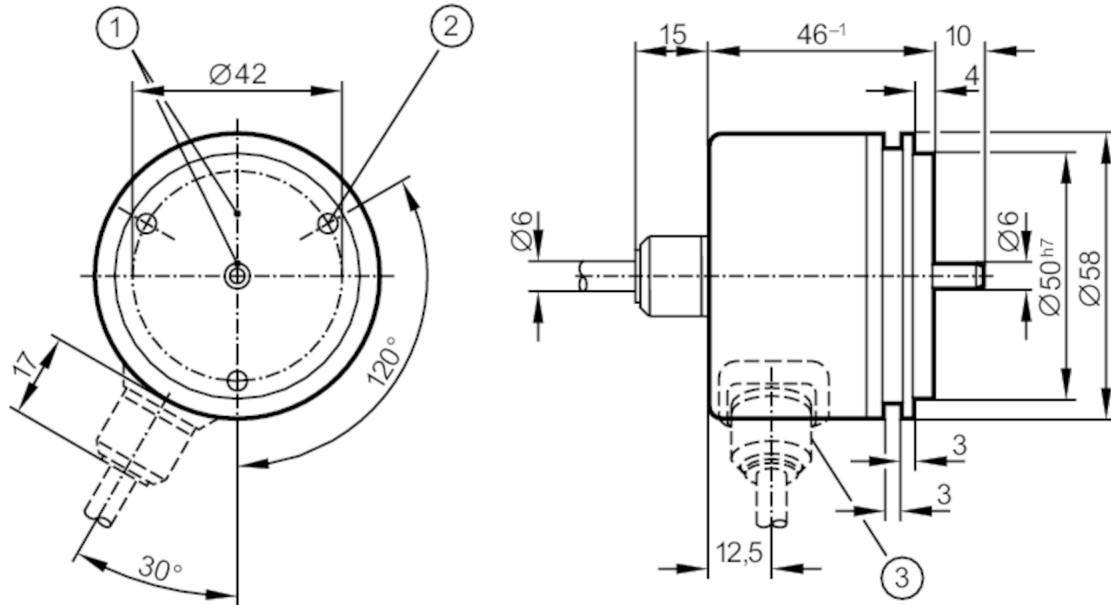

- 1 reference mark
- 2 M4 Depth 5 mm



Product characteristics

Resolution	1750 resolution
Shaft design	solid shaft
Shaft diameter [mm]	6

Electrical data

Operating voltage tolerance [%]	10
Operating voltage [V]	5 DC
Current consumption [mA]	150

Outputs

Electrical design	TTL
Max. current load per output [mA]	20
Switching frequency [kHz]	300
Phase difference A and B [°]	90

Measuring/setting range

Resolution	1750 resolution
------------	-----------------

Operating conditions

Ambient temperature [°C]	-20...100
Storage temperature [°C]	-30...100
Protection	IP 64

Tests / approvals

Shock resistance	100 g (6 ms)
Vibration resistance	10 g (55...2000 Hz)

RU1174



Incremental encoder with solid shaft

RU-1750-I05/N2

Mechanical data		
Dimensions	[mm]	Ø 58 / L = 46
Materials		aluminium
Max. revolution, mechanical	[U/min]	12000
Max. starting torque	[Nm]	1
Reference temperature torque	[°C]	20
Shaft design		solid shaft
Shaft diameter	[mm]	6
Shaft material		steel (1.4104)
Max. shaft load axial (at the shaft end)	[N]	10
Max. shaft load radial (at the shaft end)	[N]	20
Fixing flange		synchro-flange

Electrical connection

Cable: 2 m, PUR; radial

brown	A
green	A inverted
grey	B
pink	B inverted
red	0 index
black	0 index inverted
blue	L+ sensor
white	0V sensor
brown/green	L+ (Up)
white/green	0V (Un)
lilac	failure inverted
screen	housing

Diagrams and graphs

Pulse diagram

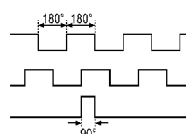

Output A
Output B
0 index

Article no longer available - archive entry