

O6H307



Diffuse reflection sensor with background suppression

O6H-FNKG/AS/4P



- 1: output function switch
2: potentiometer sensitivity



Product characteristics

Type of light	red light
Housing	rectangular
Dimensions [mm]	41.3 x 13 x 21

Application

Special feature	Background suppression
Function principle	Diffuse reflection sensor

Electrical data

Operating voltage [V]	10...30 DC
Current consumption [mA]	22; ((24 V))
Protection class	III
Reverse polarity protection	yes
Type of light	red light
Wave length [nm]	633

Outputs

Electrical design	NPN
Output function	light-on/dark-on mode; (selectable)
Max. voltage drop switching output DC [V]	2.5
Permanent current rating of switching output DC [mA]	100
Switching frequency DC [Hz]	1000
Short-circuit protection	yes
Type of short-circuit protection	pulsed

O6H307



Diffuse reflection sensor with background suppression

O6H-FNKG/AS/4P

Detection zone	
Range [mm]	2...200; (white paper 200 x 200 mm)
Range on white object (90 % remission) [mm]	2...200
Range on grey object (18 % remission) [mm]	4...200
Range on black object (6 % remission) [mm]	8...200
Range adjustable	yes
Max. light spot diameter [mm]	8
Light spot dimensions refer to	at maximum range
Background suppression available	yes

Operating conditions	
Ambient temperature [°C]	-25...80
Protection	IP 65; IP 67; IP 68; IP 69K

Tests / approvals	
EMC	EN 60947-5-2
MTTF [years]	708
UL approval	UL Approval no. E001

Mechanical data	
Weight [g]	35.8
Housing	rectangular
Dimensions [mm]	41.3 x 13 x 21
Materials	housing: stainless steel (1.4404 / 316L); plastics: PPSU; Sealing: EPDM
Lens material	PMMA
Lens alignment	side lens

Displays / operating elements		
Display	switching status	1 x LED, yellow
	operation	1 x LED, green

Remarks	
Remarks	operating voltage "supply class 2" according to cULus
Pack quantity	1 pcs.

Electrical connection

Connector: 1 x M8



Diffuse reflection sensor with background suppression

O6H-FNKG/AS/4P

Connection

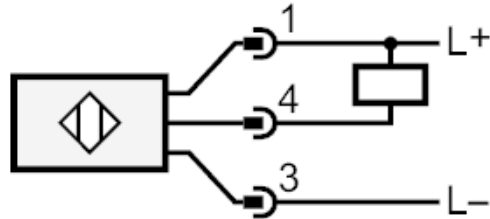

Diagrams and graphs

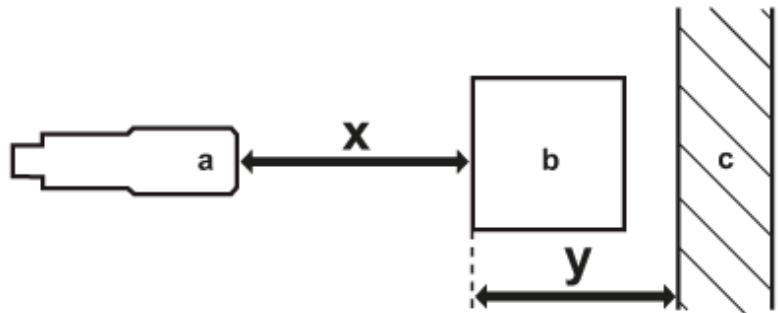

- a: sensor
- b: object
- c: background
- x: distance sensor/object [mm]
- y: min. distance object/background [mm]



Diffuse reflection sensor with background suppression

O6H-FNKG/AS/4P

accuracy graph

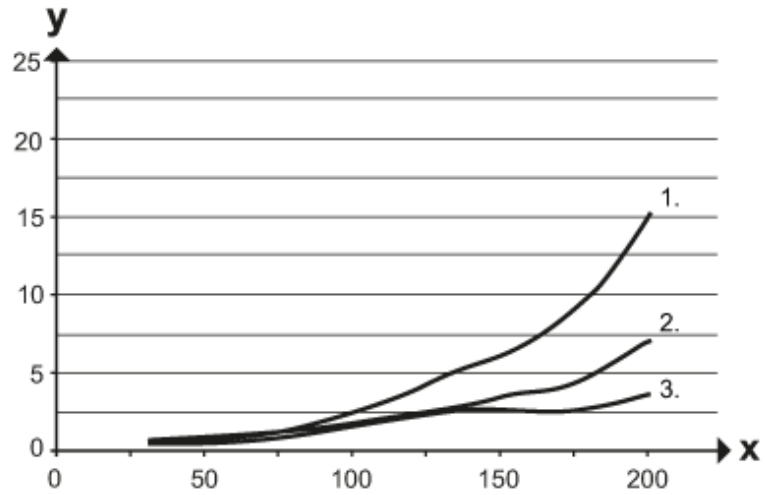

x: distance sensor/object [mm]

y: min. distance object/background [mm]

1 = object black (6 % remission) , background (white 90 % remission)

2 = object grey (18 % remission) , background (white 90 % remission)

3 = object white (90 % remission) , background (white 90 % remission)