

RV1081



Incremental encoder with solid shaft

RV-4096-I05/K

Article no longer available - archive entry

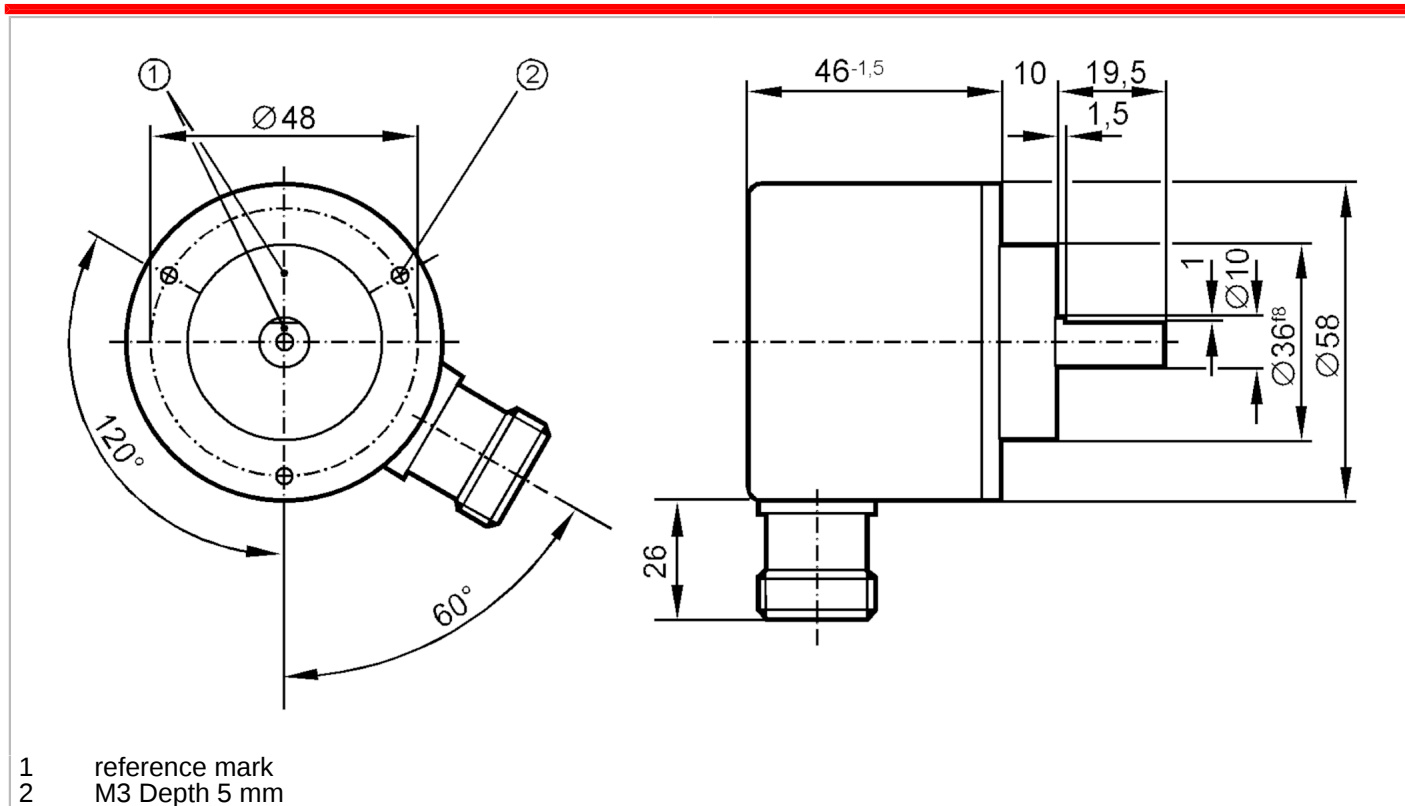

Product characteristics

Resolution	4096 resolution
Shaft design	solid shaft
Shaft diameter [mm]	10

Electrical data

Operating voltage tolerance [%]	10
Operating voltage [V]	5 DC
Current consumption [mA]	150

Outputs

Electrical design	TTL
Max. current load per output [mA]	20
Switching frequency [kHz]	300
Phase difference A and B [°]	90

Measuring/setting range

Resolution	4096 resolution
------------	-----------------

Operating conditions

Ambient temperature [°C]	-30...100
Storage temperature [°C]	-30...100
Max. relative air humidity [%]	98
Protection	IP 64

RV1081



Incremental encoder with solid shaft

RV-4096-I05/K

Tests / approvals		
Shock resistance		100 g (6 ms)
Vibration resistance		15 g (55...2000 Hz)
Mechanical data		
Dimensions [mm]		Ø 58 / L = 75.5
Materials		aluminium
Max. revolution, mechanical [U/min]		12000
Max. starting torque [Nm]		1
Reference temperature torque [°C]		20
Shaft design		solid shaft
Shaft diameter [mm]		10
Shaft material		steel (1.4104)
Max. shaft load axial (at the shaft end) [N]		10
Max. shaft load radial (at the shaft end) [N]		20

Electrical connection	
1	B inverted
2	L+ sensor
3	0 index
4	0 index inverted
5	A
6	A inverted
screen	housing
7	failure inverted
8	B
9	n.c.
10	0V (Un)
11	0V sensor
12	L+

Connector: 1 x M23 (ifm 1001.4), radial

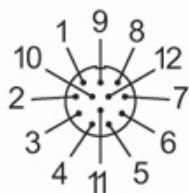

RV1081



Incremental encoder with solid shaft

RV-4096-I05/K

Diagrams and graphs

Pulse diagram



Output A

Output B

0 index

Article no longer available - archive entry