

RC6032



Incremental encoder with solid shaft

RC-0256-I24/K

Article no longer available - archive entry

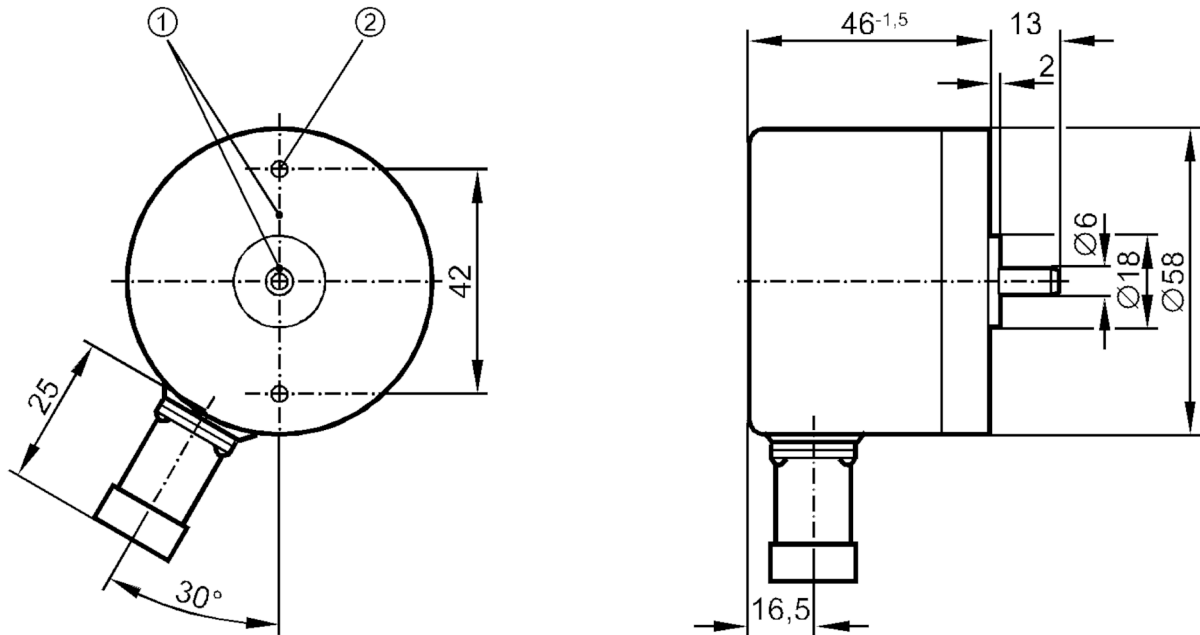

- 1 reference mark
- 2 M3 Depth 5 mm



Product characteristics

Resolution	256 resolution
Shaft design	solid shaft
Shaft diameter [mm]	6

Electrical data

Operating voltage [V]	10...30 DC
Current consumption [mA]	150

Outputs

Electrical design	HTL
Max. current load per output [mA]	50
Switching frequency [kHz]	160
Type of short-circuit protection	< 60 s
Phase difference A and B [°]	90

Measuring/setting range

Resolution	256 resolution
------------	----------------

Operating conditions

Ambient temperature [°C]	-20...85
Storage temperature [°C]	-30...100
Max. relative air humidity [%]	98
Protection	IP 64

RC6032



Incremental encoder with solid shaft

RC-0256-I24/K

Tests / approvals

Shock resistance		100 g (6 ms)
Vibration resistance		15 g (55...2000 Hz)

Mechanical data

Dimensions [mm]		Ø 58 / L = 59
Materials		aluminium
Max. revolution, mechanical [U/min]		12000
Max. starting torque [Nm]		1
Reference temperature torque [°C]		20
Shaft design		solid shaft
Shaft diameter [mm]		6
Shaft material		steel (1.4104)
Max. shaft load axial (at the shaft end) [N]		10
Max. shaft load radial (at the shaft end) [N]		20

Electrical connection

1	B inverted
2	n.c.
3	0 index
4	0 index inverted
5	A
6	A inverted
7	failure inverted
8	B
9	n.c.
10	0V
11	n.c.
12	L+

Connector: 1 x M23 (ifm 1001.4), radial

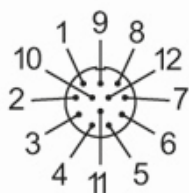

RC6032



Incremental encoder with solid shaft

RC-0256-I24/K

Diagrams and graphs

Pulse diagram



Output A

Output B

0 index

Article no longer available - archive entry