

E60204

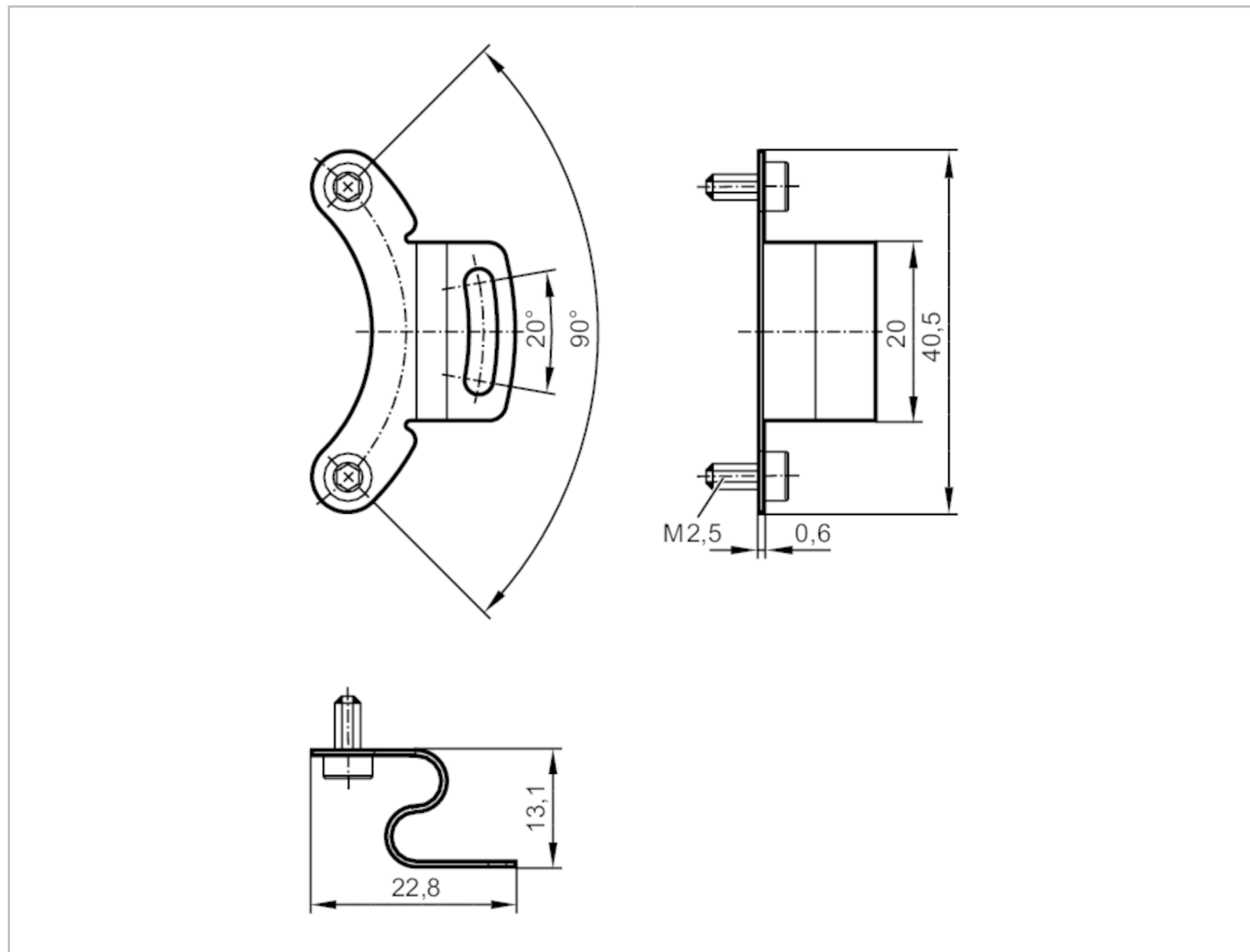

Stator coupling for encoders

STATOR COUPLING RA3



Mechanical data	
Weight [g]	5.2
Materials	stainless steel (1.4310 / 301)
Tightening torque [Nm]	0.6
Accessories	
Accessories (supplied)	socket head screws: 2 screw type: M2,5 x 0,45-6H, TX 8
Remarks	
Pack quantity	1 pcs.