

RV6132



Incremental encoder with solid shaft

RV-0005-I24/K

Article no longer available - archive entry

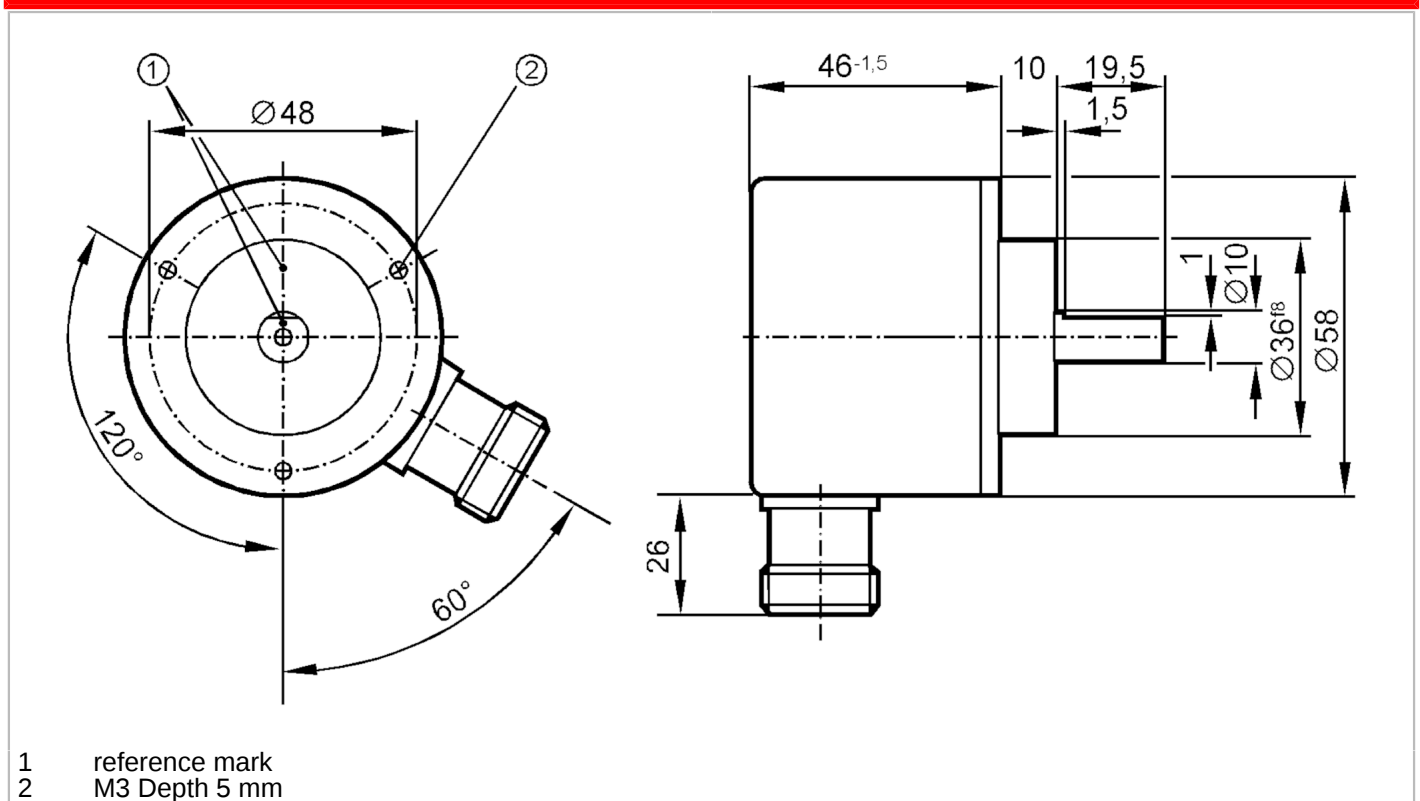

Product characteristics

Resolution	5 resolution
Shaft design	solid shaft
Shaft diameter [mm]	10

Electrical data

Operating voltage [V]	10...30 DC
Current consumption [mA]	150

Outputs

Electrical design	HTL
Max. current load per output [mA]	50
Switching frequency [kHz]	160
Type of short-circuit protection	< 60 s
Phase difference A and B [°]	90

Measuring/setting range

Resolution	5 resolution
------------	--------------

Operating conditions

Ambient temperature [°C]	-30...85
Storage temperature [°C]	-30...100
Max. relative air humidity [%]	98
Protection	IP 64

RV6132



Incremental encoder with solid shaft

RV-0005-I24/K

Tests / approvals

Shock resistance		100 g (6 ms)
Vibration resistance		15 g (55...2000 Hz)

Mechanical data

Dimensions [mm]	Ø 58 / L = 75.5
Materials	aluminium
Max. revolution, mechanical [U/min]	12000
Max. starting torque [Nm]	1
Reference temperature torque [°C]	20
Shaft design	solid shaft
Shaft diameter [mm]	10
Shaft material	steel (1.4104)
Max. shaft load axial (at the shaft end) [N]	10
Max. shaft load radial (at the shaft end) [N]	20

Electrical connection

1	B inverted
2	L+ sensor
3	0 index
4	0 index inverted
5	A
6	A inverted
7	failure inverted
8	B
9	n.c.
10	0V
11	0V sensor
12	L+

Connector: 1 x M23 (ifm 1001.4), radial

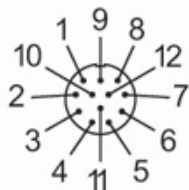

RV6132



Incremental encoder with solid shaft

RV-0005-I24/K

Diagrams and graphs

Pulse diagram



Output A

Output B

0 index

Article no longer available - archive entry