

E11819

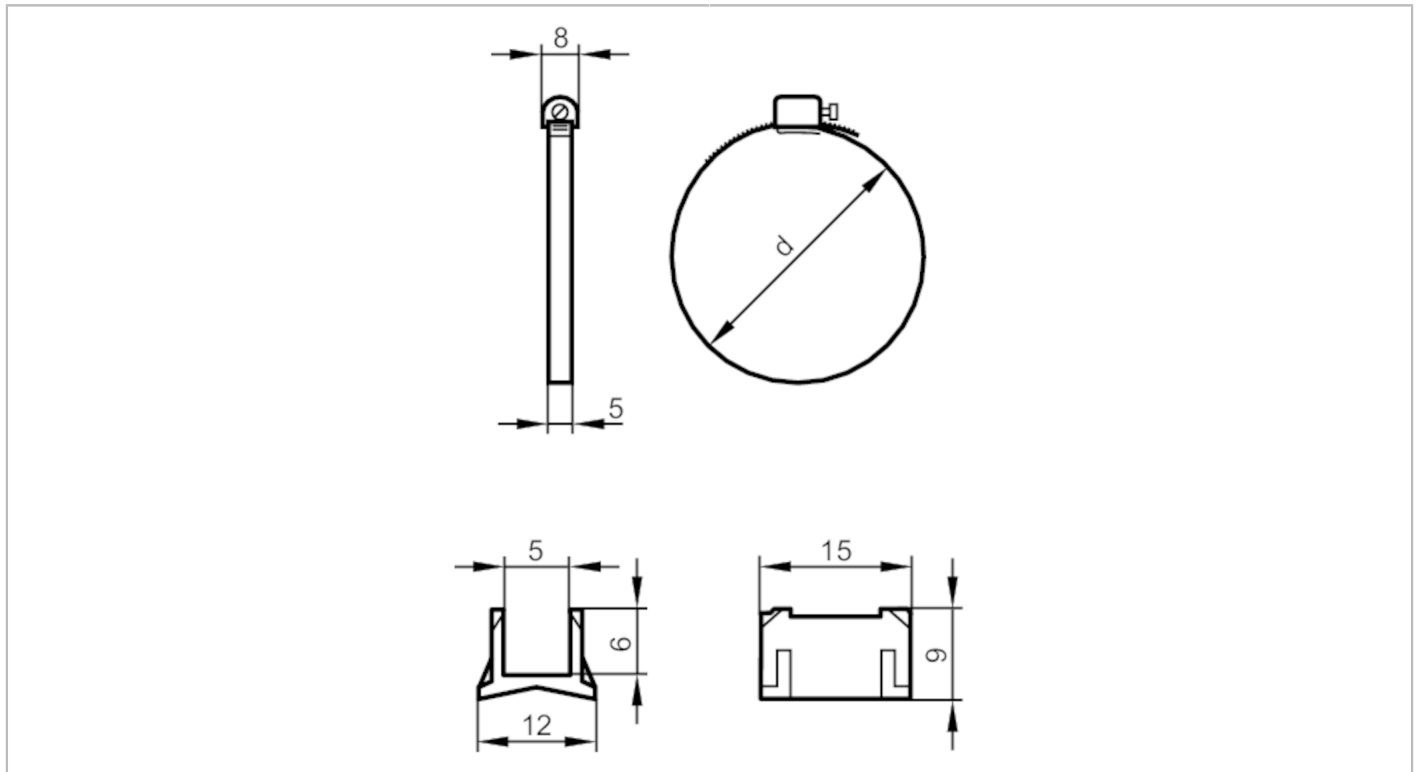

Fixing strap for clean-line cylinders

FIXING STRAP CLEAN-LINE CYL



Application	
Design	for types MKT
Mechanical data	
Weight [g]	7.4
Dimensions [mm]	Ø 40
Materials	Adapter: PA; fixing strap: stainless steel (1.4305 / 303)
Piston diameter [mm]	40
Clamping range [mm]	38...49
Accessories	
Items supplied	Adapter: 1x, for types, MKT Fixing strap for clean-line cylinders: 1x
Remarks	
Pack quantity	1 pcs.