

RU6022



Incremental encoder with solid shaft

RU-0800-I24/L2

Article no longer available - archive entry

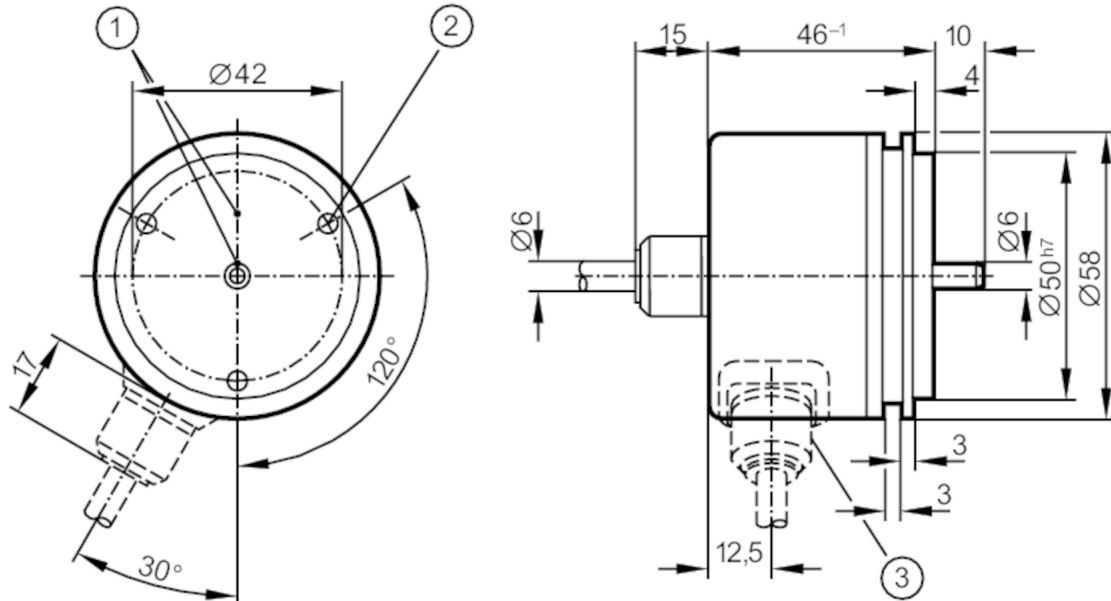

- 1 reference mark
- 2 M4 Depth 5 mm



Electrical data	
Operating voltage [V]	10...30 DC
Current consumption [mA]	150
Outputs	
Electrical design	HTL
Max. current load per output [mA]	50
Switching frequency [kHz]	300
Type of short-circuit protection	< 60 s
Phase difference A and B [°]	90
Measuring/setting range	
Resolution	800 resolution
Operating conditions	
Ambient temperature [°C]	-20...85
Storage temperature [°C]	-30...100
Max. relative air humidity [%]	98
Protection	IP 64
Tests / approvals	
Shock resistance	100 g (6 ms)
Vibration resistance	10 g (55...2000 Hz)

RU6022



Incremental encoder with solid shaft

RU-0800-I24/L2

Mechanical data		
Dimensions	[mm]	Ø 58 / L = 46
Materials		aluminium
Max. revolution, mechanical	[U/min]	12000
Max. starting torque	[Nm]	1
Reference temperature torque	[°C]	20
Shaft design		solid shaft
Shaft diameter	[mm]	6
Shaft material		steel (1.4104)
Max. shaft load axial (at the shaft end)	[N]	10
Max. shaft load radial (at the shaft end)	[N]	20
Fixing flange		synchro-flange

Electrical connection

Cable: 2 m, PUR; axial

brown	A
green	A inverted
grey	B
pink	B inverted
red	0 index
black	0 index inverted
blue	L+ sensor
white	0V sensor
brown/green	L+ (Up)
white/green	0V (Un)
lilac	failure inverted
screen	housing

Diagrams and graphs

Pulse diagram

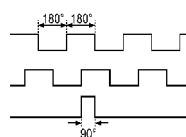

Output A

Output B

0 index

Article no longer available - archive entry