

MK5014



Cylinder sensor for integrated profile cylinders

MKP3000-BPKG

Article no longer available - archive entry

Alternative articles: MK5115 + E11801

When selecting an alternative article and accessories please note that technical data may differ!

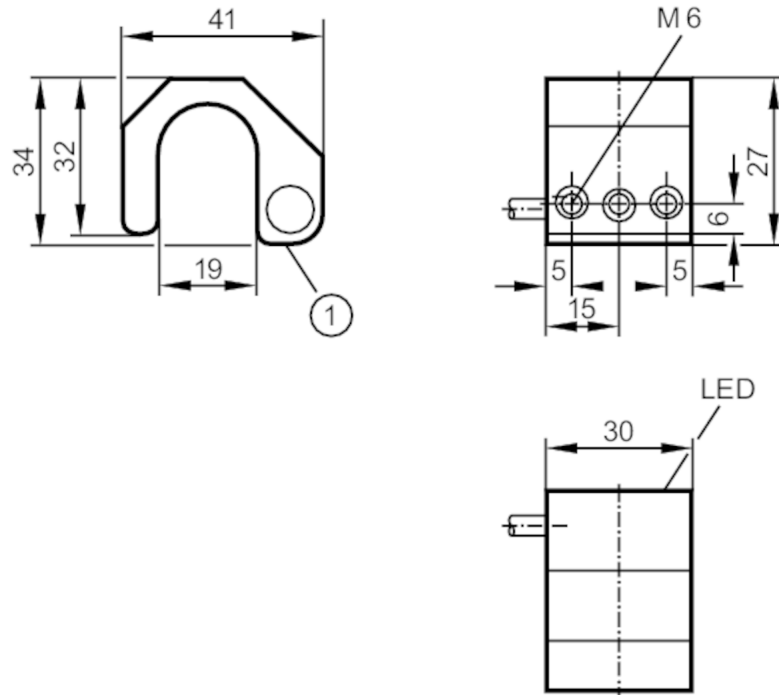

1 Sensing face



Product characteristics

Electrical design	PNP
Output function	normally open
Dimensions [mm]	41 x 30 x 27

Electrical data

Operating voltage [V]	10...30 DC
Current consumption [mA]	< 10
Reverse polarity protection	yes
Max. power-on delay time [ms]	2

MK5014



Cylinder sensor for integrated profile cylinders

MKP3000-BPKG

Outputs		
Electrical design		PNP
Output function		normally open
Max. voltage drop switching output DC	[V]	2
Permanent current rating of switching output DC	[mA]	300
Switching frequency DC	[Hz]	5000
Short-circuit protection		yes
Type of short-circuit protection		pulsed
Overload protection		yes
Detection zone		
Response sensitivity	[mT]	3
Travel speed	[m/s]	< 5
Accuracy / deviations		
Hysteresis	[mm]	1
Repeatability	[mm]	0.1
Operating conditions		
Ambient temperature	[°C]	-25...75
Protection		IP 67
Tests / approvals		
EMC	EN 60947-5-2	
Shock/vibration resistance	30 g (11 ms) / 10-55 Hz (1 mm)	
Mechanical data		
Sensing face		front
Cylinder type		integrated profile cylinders
Dimensions	[mm]	41 x 30 x 27
Materials		aluminium; plastics
Displays / operating elements		
Display	switching status	1 x LED, yellow
Remarks		
Pack quantity		1 pcs.

MK5014



Cylinder sensor for integrated profile cylinders

MKP3000-BPKG

Electrical connection

Cable: 2 m, PUR / PVC; 3 x 0.25 mm²

Connection



Core colours :

BN =

brown

BU =

blue

BK =

black